

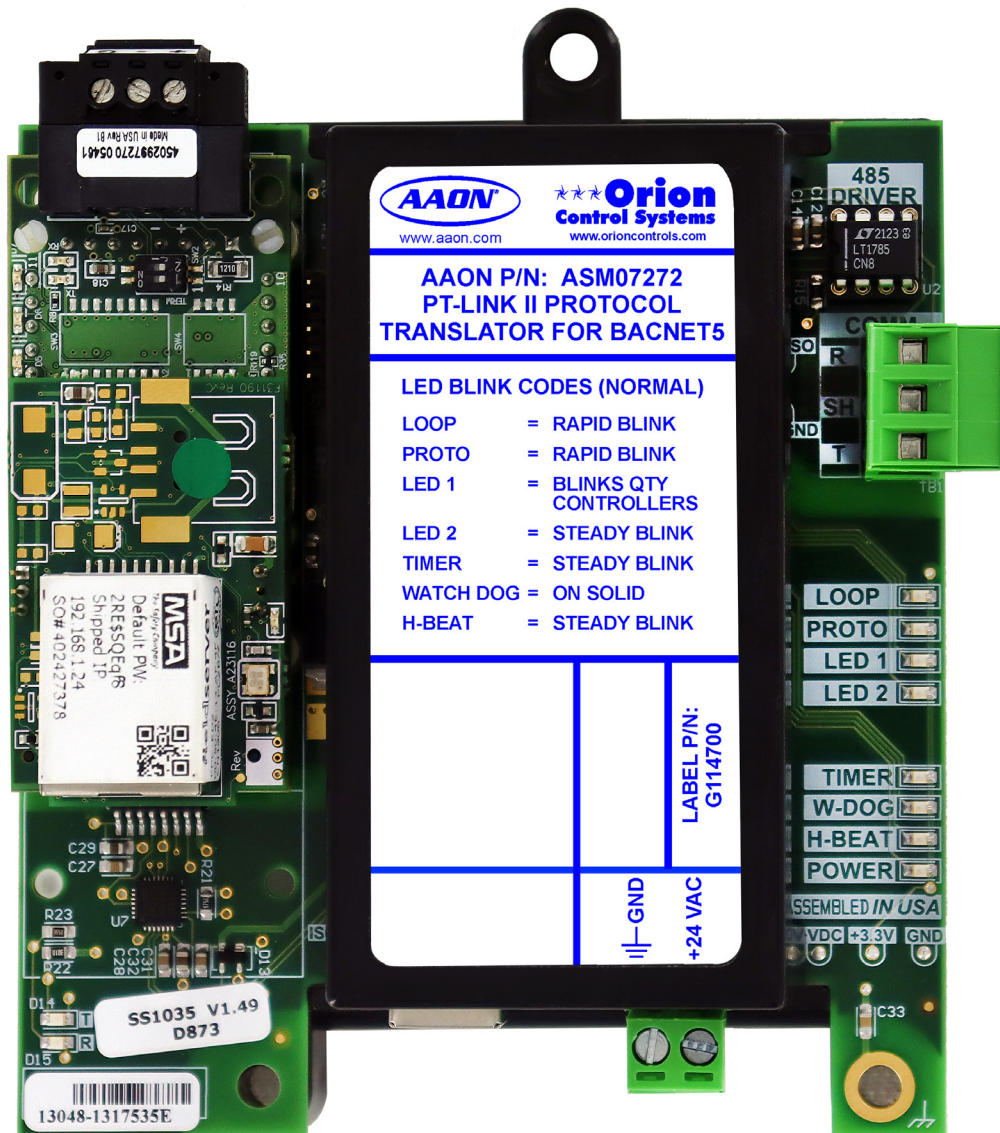

PT-Link II BACnet5 Technical Guide



PT-LINK II BACNET5 TECHNICAL GUIDE

REVISION AND DATE	CHANGE
Rev. A, 12 October 2022	Initial release



www.aeon.com

**This manual is available for download from
www.aeon.com/library**

AAON, Inc.
2425 South Yukon Ave.
Tulsa, OK 74107-2728
www.aeon.com
Factory Technical Support Phone: 918-382-6450
Controls Support Phone: 866-918-1100
All rights reserved. © October 2022 AAON, Inc.
It is the intent of AAON to provide accurate and current product information. However, in the interest of product improvement, AAON reserves the right to change pricing, specifications, and/or design of its product without notice, obligation, or liability.
AAON P/N: G114680 REV A

AAON® is a registered trademark of AAON, Inc., Tulsa, OK. BACnet® is a registered trademark of ASHRAE Inc., Atlanta, GA. BITZER® is a registered trademark of BITZER Kühlmaschinenbau GmbH.

CONTENTS

TABLE OF CONTENTS	3
GENERAL INFORMATION	5
Overview	5
System Requirements.....	6
CONFIGURATION	7
Quick Start Guide.....	7
Connection and Wiring Information.....	8
Graphic User Interface.....	9
Ethernet Connection	10
IP Address Configuration	11
GRAPHIC USER INTERFACE	13
Configuration Parameters	13
Setup.....	15
View	17
BACNET AND DATA ARRAY INFORMATION	18
Addressing Devices in a BACnet Network.....	18
Data Arrays	19
VCCX2 Controller	20
VCB-X Controller	40
VCM-X Modular Controller.....	51
VCM-X WSHP (Tulsa) Controller	52
VCM-X WSHP (Coil) Controller.....	54
VCM-X Controller.....	55
SA Controller.....	62
VCM Controller	68
TROUBLESHOOTING	75
Communications	75
LEDs	76
PT-Link Connections.....	78
BACNET PICS	79
ProtoCessor Driver BACnet PICS.....	79

FIGURES

Figure 1:	PT-Link Dimensions and Components.....	7
Figure 2:	PT-Link II BACnet Interface Wiring.....	8
Figure 3:	Connecting with Crossover Cable.....	10
Figure 4:	Diagnostic Capture	75
Figure 5:	PT-Link LED Locations	76
Figure 6:	PT-Link LEDs	77
Figure 7:	PT-Link Components	77
Figure 8:	Connections Window	78

TABLES

Table 1:	PT-Link Compability with Controllers.....	6
Table 2:	PT-Link Interface Technical Data.....	6

Overview

Overview

The PT-Link II BACnet5 (PT-Link) provides bi-directional communication between the BACnet MS/TP protocol network and up to four AAON controllers. If more than four AAON controllers are present in a system, additional PT-Link devices are required.

The PT-Link II BACnet5 (ASM07272) is sold only as a direct replacement in existing installations of the PT-Link II BACnet4 (ASM01881). If using the VCCX2 Controller, use the on-board BACnetMS/TP interface of the VCCX2 when BACnet is needed.

Differences Between PT-Link II BACnet4 and PT-Link II BACnet5

The primary differences between the two versions:

- Different Processor
- Lack of dip switches
- Configuration is accomplished via the web-browser based graphic user interface (GUI)
- Ability to change the master password
- Establish user accounts with different rights than the admin account.

NOTE: The PT-Link II BACnet5 does not support RSMZ Modules installed with a VCCX2 Controller.

Features

Data Sharing

The PT-Link provides values from points on the AAON side of the gateway to BACnet devices as if the values were originating from BACnet objects.

It allows BACnet devices to modify point values on the AAON controller side of the PT-Link by using standard BACnet write services.

Scheduling

The PT-Link allows BACnet devices to send Schedule events to the AAON controller side of the gateway by using standard BACnet services.

GENERAL INFORMATION

System Requirements

Controller Compatibility

Any of the following types of controllers can be connected:

- VCCX2 Controller
- VCB-X Controller
- VCM-X Controller
- SA Controller
- VCM Controller
- VAV/CAV Controller
- MUA II Controller

The software label located on the controller identifies the controller type. The label is located on the EPROM on older devices. If the controller label does not match any of the SS or Y numbers listed above, the controller will not work with the PT-Link BACnet.

NOTE: Documentation for all controllers can be found on our website: www.aon.com/library

CONTROLLER COMPATIBILITY	
Controller	Software
VCCX2	DT003800-001/SS1088 Version 1.02 and up
VCB-X	SS1051 Version 2.0 and up
VCM-X Modular	SS1030 & SS1034
VCM-X WSHP	Tulsa: SS1032 Coil: SS1033
VCM-X	SS1026 & Y200920 Version 2.0 and up
SA	Y200921
VCM	SS1016, Y200409, Y200616, Y200822
VAV/CAV	SS1003, Y200301
MUA II	SS1004, Y200405

Table 1: PT-Link Compability with Controllers

Hardware Specifications

TECHNICAL DATA	
Specification	Data
BACnet-MS/TP Loop	9600, 19200, 38400, 76800 Mbps
Controller Loop	RS-485, 9600 Baud Rate
Network Protocol	BACnet
Protocol (Watt Comm Loop)	HSI Open Protocol Token Passing
Power Input Voltage	18-30 VAC
Power Consumption	10 VA Maximum
Operating Temp	-22°F to 158°F
Operating Humidity	0-95% RH Non-Condensing
Weight	4.5 oz.

Table 2: PT-Link Interface Technical Data

System Requirements

The following is needed for configuration:

- Computer running Microsoft Windows 10 operating system
- Ethernet crossover cable
- PT-Link software located on included flash drive and downloadable from www.aon.com/aon-controls-technical-support

NOTE: The software is the same as the previous version of the PT-Link. The software on the website can be used for either device.

CONFIGURATION

Quick Start Guide

Configure the PT-Link

1. Connect the PT-Link to the controller(s) on the system (up to four controllers) and connect the PT-Link to the BACnet Network, see **Figure 2, page 8**. Controllers must be addressed as 1, 2, 3 and 4.
2. Verify all controllers are using the same communication speed.
3. Obtain the following from the Building Automation System (BAS) Integrator:
 - BACnet MAC address (System Node ID)
 - MS/TP network baud rate
4. Verify the BACnet Device Instance which defaults to 50,000. The ID is generated by adding the MAC address to the Device Instance ID. If the Device Instance must be set to something other than in the range of 50,001 to 50,127, see **Setting Device Instance ID, page 14**, to change the Device Instance ID value.

5. Configure the PT-Link using the **Configuration Parameters, page 13**:

- Set the **<BACnet MSTP Baud Rate>**.
- Set the **<BACnet MSTP MAC Address>**. The BACnet MS/TP MAC Address MUST be set between 1 and 127.

Only one MAC address is set for the PT-Link regardless of how many devices are connected to it.

The BACnet MS/TP MAC addresses of the PT-Link must be set to a value between 1 and 127 so the Building Management System (BMS) front end can find the PT-Link via the BACnet auto discovery function. MAC addresses from 128 to 255 cannot be auto discovered by the BMS front end.

NOTE: AAON only supports BACnet MS/TP applications.

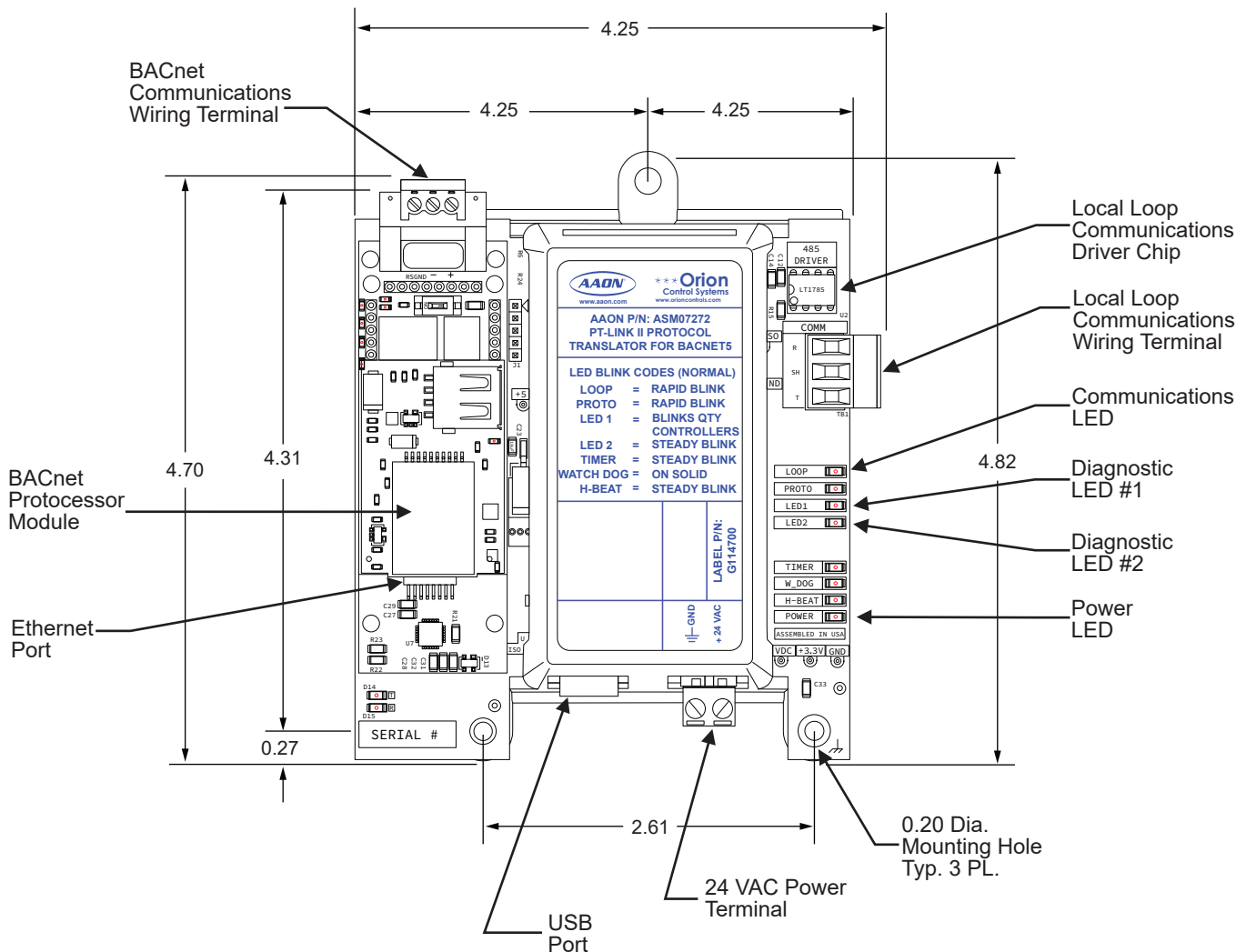
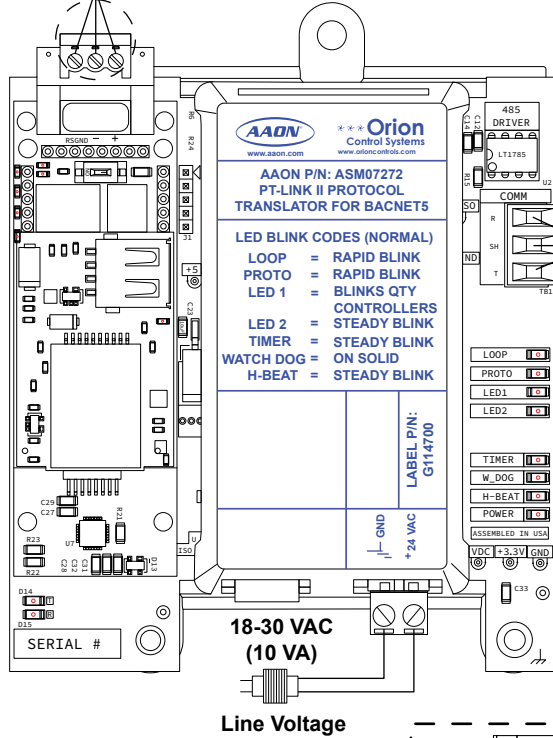

Figure 1: PT-Link Dimensions and Components

CONFIGURATION

Connection and Wiring Information

MS/TP Connection to BACnet Network



IMPORTANT WIRING NOTES

- Use the daisy-chain topology as shown in this diagram. Do not use a star topology with multiple units tied directly to the PT Link.
- Up to four controllers can be connected.
- Controllers can be addressed in any order, regardless of how the daisy chain is wired, but they must be addressed 1-4 ONLY even if multiple PT-Links are in use.
- Controllers should be set to the same communication speed.

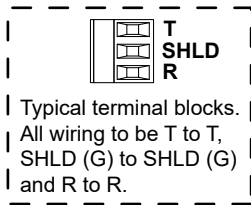

CAUTION

The communications terminal block must be disconnected before connecting the Modular Service Tool. After programming the controller(s), disconnect the service tool and then reconnect the communication terminal block. Failure to follow this procedure will cause communication problems.

NOTE

Controllers can be programmed using Prism2, the USB Link II, or the Modular Service Tool. The modular system manager should not be used on a system that has a PT-Link installed.

WIRING NOTES

- All wiring to be in accordance with local and national electrical codes and specifications.
- All communication wiring to be 18 gauge minimum, 2 conductor twisted pair with shield. Use Belden #82760 or equivalent.

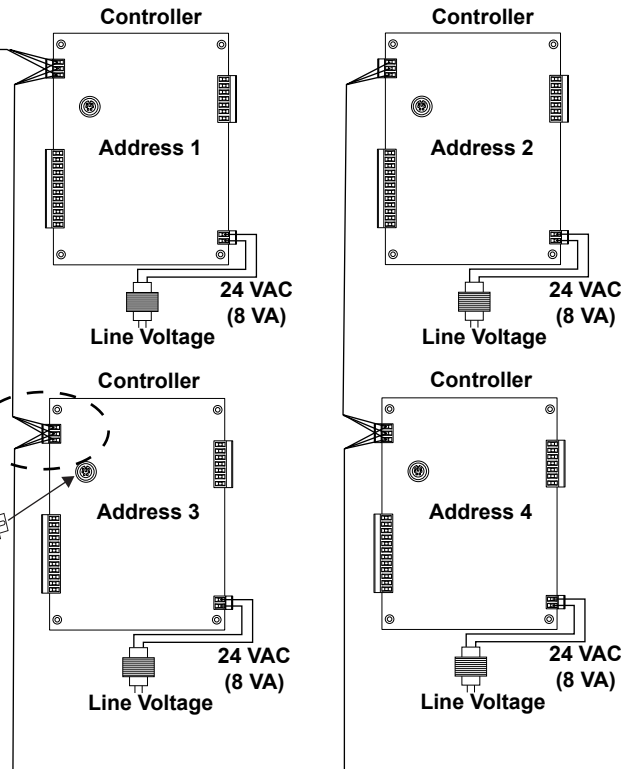
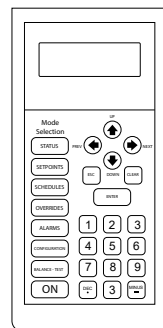

Figure 2: PT-Link II BACnet Interface Wiring

Graphic User Interface

The PT-Link is configured using a GUI which is a password protected web-browser based interface that uses a combination of technologies and devices to provide a platform to gather and process information. The GUI can do the following:

- Set the BACnet MS/TP baud rate
- Set the BACnet MS/TP MAC address
- Change the BACnet Device Instance to something other than 50,001 to 50,127
- Check the status and diagnostics of the PT-Link, such as network settings, connection information, node information, map descriptors, and error messages
- Monitor the PT-Link's internal data and parameters
- Change or update the PT-Link's internal data and parameters
- Restart the PT-Link

The following items are needed to run the GUI:

- **PC Requirements**—A computer with a web browser that connects over Ethernet on port 80. Computer and network firewalls must be opened for Port 80 to allow the GUI to function.
- **Software Requirements**—Chrome 19.0 and higher, Firefox 13.0 and higher, Opera 11.0 and higher, Microsoft Edge, or Safari 4.1 and higher. Internet Explorer is not supported.

CONFIGURATION

Ethernet Connection

Hardware Connection

1. Connect the PT-Link directly to the computer by using a standard Cat5 Ethernet crossover cable (by others) as shown. See **Figure 3, this page**, for details.
2. Power up the PT-Link by plugging in the power cable. The PT-Link may take up to three minutes to power up completely. Once the PT-Link is powered up, the RUN LED blinks continuously on the ProtoCessor Board. See **Figure 6, page 77**, for a diagram showing the location of the ProtoCessor RUN LED.

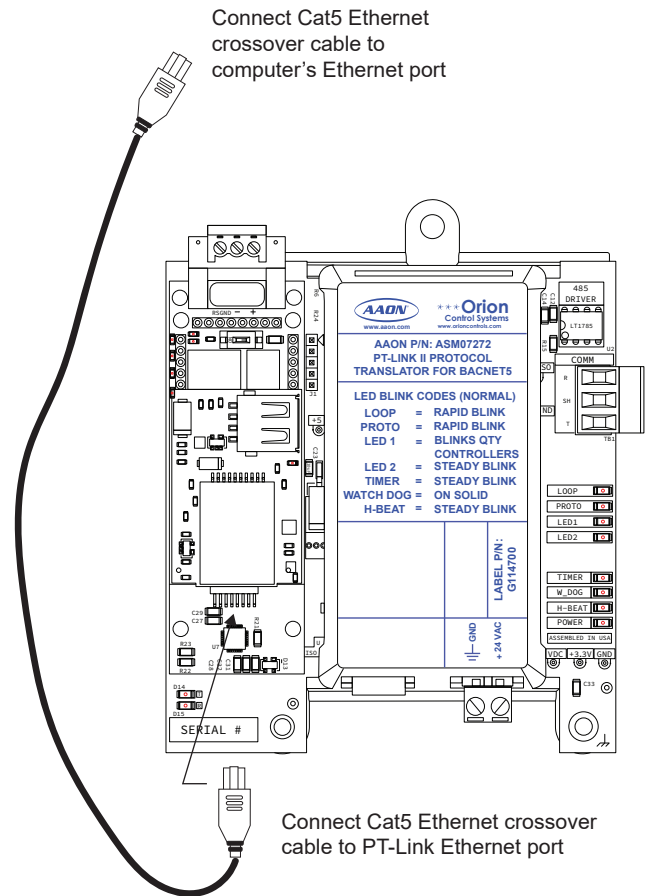

Figure 3: Connecting with Crossover Cable

CONFIGURATION

IP Address Configuration

Computer IP Address Setup for Windows 10

In order for the PT-Link to communicate properly, it is imperative to set the IP address of both the PT-Link as well as the computer to be within the same network scheme. This may require changing the IP address on the computer. The following instructions explain how to configure the IP address for Microsoft Windows 10 operating system.

NOTE: The best practice is to ensure the firewall and anti-virus software are turned off before proceeding.

NOTE: The following IP Address Configuration is based on the PT-Link having a default IP address of 192.168.1.24. If the IP address of the PT-Link has been changed by previous configuration, get the assigned IP address before moving forward.

The following instructions explain how to change the computer's IP address.

1. Right click the Windows icon or **<start>**; then click **<Network Connections>**.

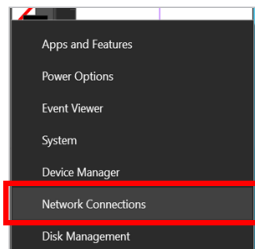

2. Click **<Network and Sharing Center>**.

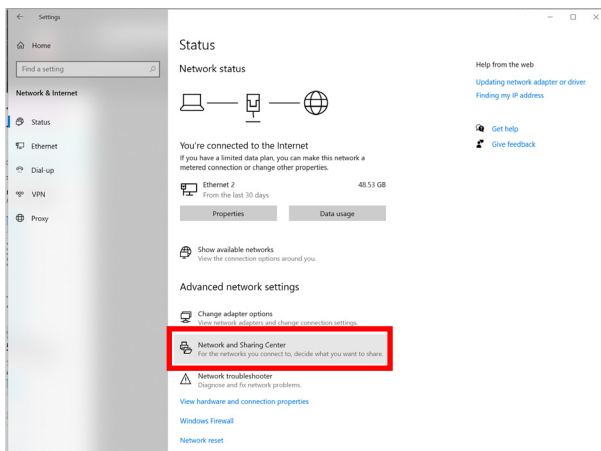

3. The **Network and Sharing Center** window appears. Select the name of the physical port the crossover is connected to (in the example below, that is Ethernet 2).

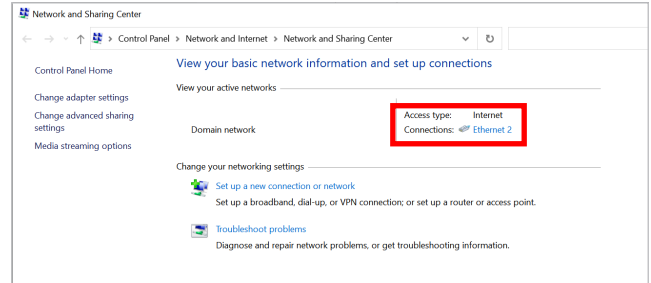

4. The **Local Area Connection Status** window appears. Click the **<Properties>** button.

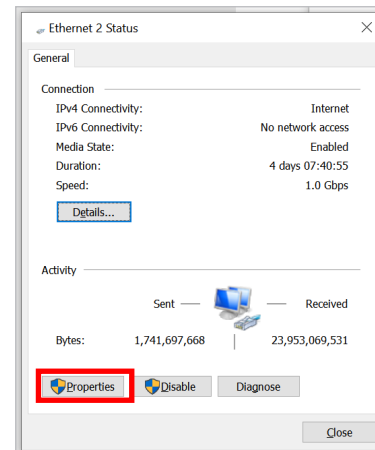

5. In the **Properties** window, select the **<Internet Protocol Version 4>**. Click **<Properties>**.

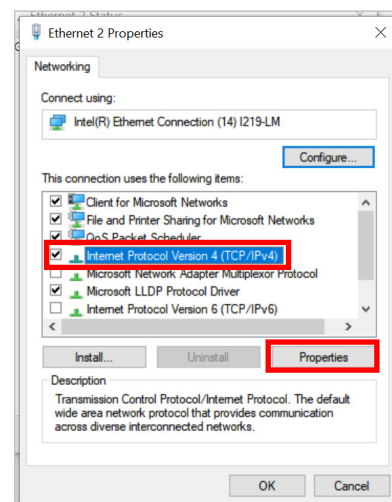

IP Address Configuration

- In the **Internet Protocol Version 4 Properties** window, select the option **<Use the following IP address:>**. Type in the following information:
 - IP address: **192.168.1.5**
 - Subnet mask: **255.255.255.0**
 - Default gateway: leave the setting blank as shown below
 - Select **<Use the following DNS server addresses:>** and leave them blank as shown below

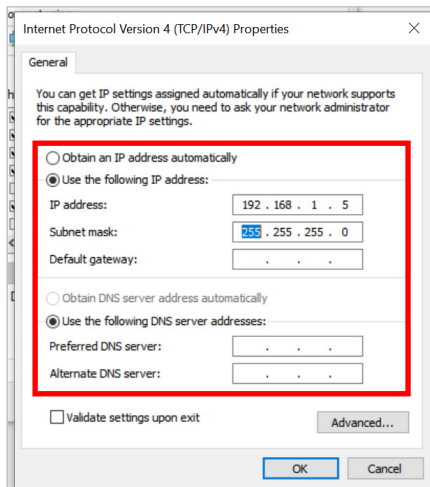

- Click **<OK>** or **<Close>** until all of the above windows are closed. The computer may need to be restarted before the new values are valid.

Configuration Parameters

Log In

1. After setting the PC to be on the same network scheme as the PT-Link, open a web browser on the PC.
2. Using the URL address bar (not the search text box), enter the PT-Link IP address plus **/login/** so it looks similar to below. The default address is 192.168.1.24.

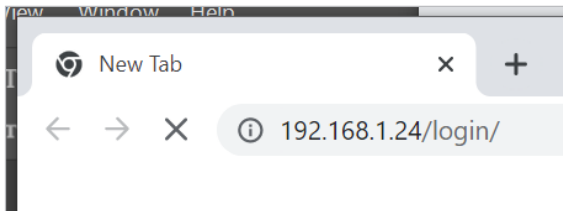

3. Enter the username and password. The default username is **admin**; the default password is printed on the processor label.

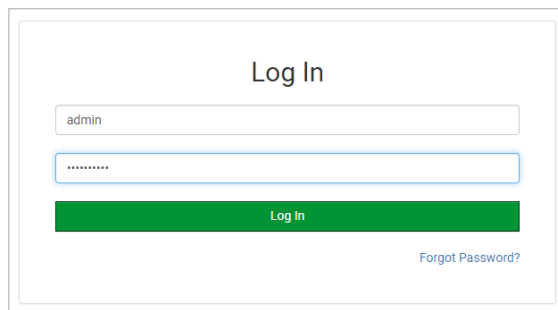

Landing Page

1. The **Configuration Parameters** page is displayed as the landing page with a successful login.
2. From this page, click **<System Restart>** to restart the system or click **<Diagnostics & Debugging>** to access the **Navigation Window** for more options such as **User Management** and **Network Settings**.

Parameter Name	Parameter Description	Value
protocol_select	Protocol Selector Set to 1 for BACnet MSTP Set to 2 for BACnet IP Set to 3 for Metasys N2	1 <input type="button" value="Submit"/>
bac_device_id	BACnet Device Instance This sets the BACnet device instance. (1 - 4194303)	50000 <input type="button" value="Submit"/>
bac_mac_addr	BACnet MSTP Mac Address This sets the BACnet MSTP MAC address. (1 - 127)	127 <input type="button" value="Submit"/>
bac_baud_rate	BACnet MSTP Baud Rate This sets the BACnet MSTP baud rate. (9600/19200/38400/76800)	38400 <input type="button" value="Submit"/>
bac_max_master	BACnet MSTP Max Master This sets the BACnet MSTP max master. (1 - 127)	127 <input type="button" value="Submit"/>
bac_cov_option	BACnet COV This enables or disables COVs for the BACnet connection. Use COV_Enable to enable. Use COV_Disable to disable. (COV_Enable/COV_Disable)	COV_Disable <input type="button" value="Submit"/>

HELP (?)

Configuration Parameters

Setting Device Instance ID

The Device Instance ID can be changed on the **Configuration Parameters** page.

1. The Device Instance ID field is presented displaying the current value (default = 50,000).

Parameter Name	Parameter Description	Value
protocol_select	Protocol Selector Set to 1 for BACnet MSTP Set to 2 for BACnet IP Set to 3 for Metasys N2	<input type="text" value="1"/> <input type="button" value="Submit"/>
bac_device_id	BACnet Device Instance This sets the BACnet device instance. (1 - 4194303)	<input type="text" value="50000"/> <input type="button" value="Submit"/>

2. Change the value of Device Instance ID to establish the desired Device Instance value and click **<Submit>**.

Device Instance = Device Instance ID + BACnet MSTP Mac Address

Setup

User Management

The PT-Link is pre-configured with one Admin user account that cannot be deleted – only the password can be changed.

Add new users and change passwords, in **User Management**.

Go to User Management

In the **Navigation** window on the left of the screen, click **<Setup>** and then click **<User Management>**.

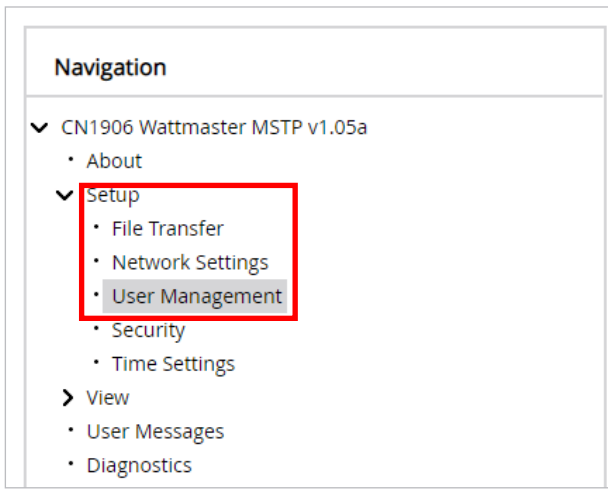

Create New User

1. To create a new user, click **<Create User>**.

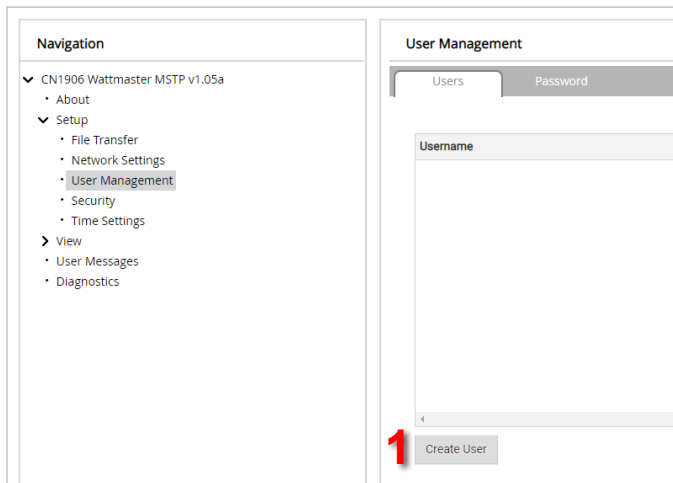

2. Enter a unique user name in the **Username** field.
3. Select a **Security Group**. Security Groups are defined by account names: Admin, Operator, and Viewer. Each account requires a unique password. The Admin account can modify and view any settings or data. The Operator account can modify and view any data. The Viewer account can view data, but cannot make any changes or restart the interface.

4. Enter a password in the **Password** field. AAON recommends passwords be at least 8-12 characters long and have at least three of the following characteristics: uppercase letters, lowercase letters, numbers, and symbols.
5. Enter the password again in the **Confirm Password** field.
6. Click **<Create>**.

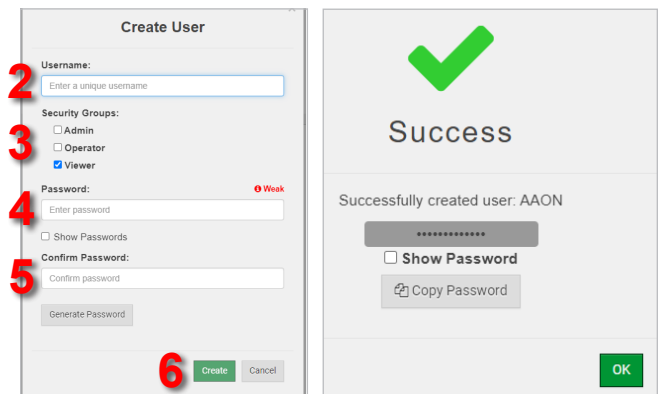

Password Management

The **Password** tab allows the default admin account password to be changed. The password printed on the PT-Link will no longer be valid if this is changed to something else. For best security practices, AAON highly recommends the default password be changed.

1. In **Setup > User Management**, click the **<Password tab>**.
2. Type in new password in the **Password** field and again in the **Confirm Password** field.
3. Click **<Confirm>**.

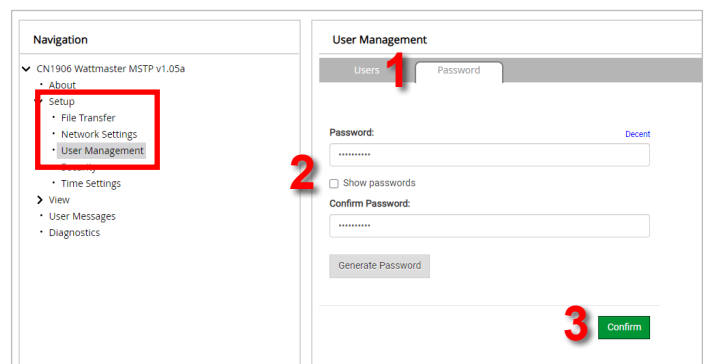

Setup

Network Settings

In the **Navigation** window click **<Setup>** then click **<Network Settings>**. The **Networks Settings** window appears.

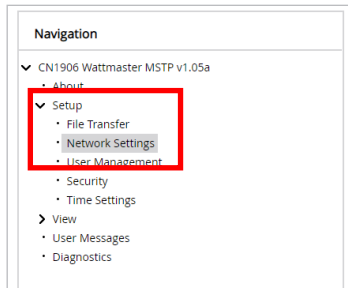

The Ethernet adapter settings of the PT-Link can be changed in the **Network Settings** window. The ETH1 adapter IP address, Netmask, and default Gateway can be changed by entering values in the applicable fields and click **<Save>**.

NOTE: The only time the IP address should be changed is during the initial configuration and/or during troubleshooting.

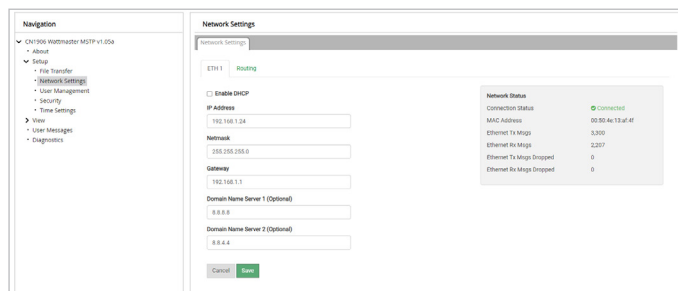

NOTE: Enabling the DHCP client on an adapter will cause the static IP address settings to be overruled by a DHCP server on the network.

The PT-Link's built in DHCP server can be enabled to establish easy connection for support purposes. Set the laptop or computer to automatically obtain an IP address to use this feature. Note that the Field Server DHCP server periodically checks for other DHCP servers on the network and disables itself if any other DHCP servers exist on the network. This mode of operation is because the DHCP server is strictly for support purposes and does not have all of the features of a commercial DHCP server. Setting the default gateway IP address to the network gateway ensures the device is reachable on the internet.

View

Data Arrays

1. In the **Navigation** window, click **<View>** then click **<Data Arrays>** to expand the menu.

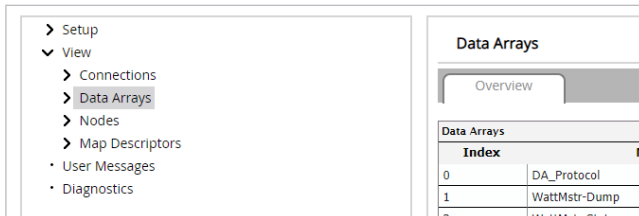

2. Click on the controller name.

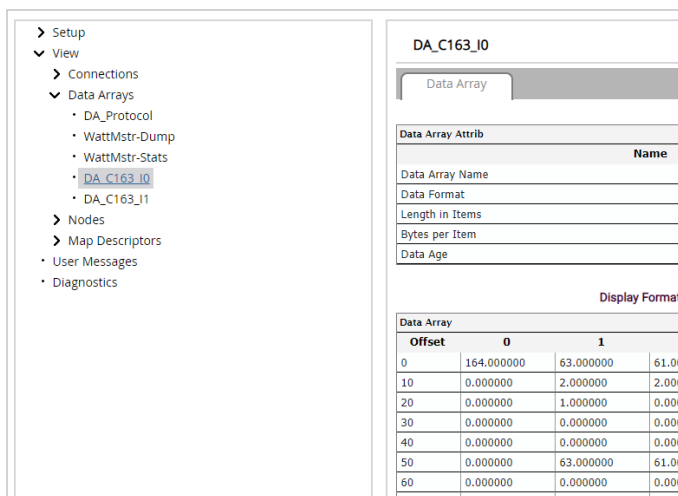

3. The **Controller's Data Array** table displays. The example below, DA_C163_I0, is a VCM-X Controller. Cross reference the values shown in the **Data Array** table with the listed BACnet parameter names, **beginning on page 20**.

Offset	0	1	2	3	4	5	6	7	8	9
0	164.000000	63.000000	61.000000	0.000000	0.000000	76.400002	76.599998	0.000000	76.400002	0.000000
10	0.000000	2.000000	2.000000	1.000000	0.000000	0.000000	0.000000	1.000000	0.000000	0.000000
20	0.000000	1.000000	0.000000	0.000000	10.000000	100.000000	0.000000	0.000000	0.000000	0.000000
30	0.000000	0.000000	0.000000	0.000000	0.000000	0.000000	0.000000	0.000000	0.000000	0.000000
40	0.000000	0.000000	0.000000	76.599998	0.000000	50.000000	55.000000	0.000000	0.000000	0.000000
50	0.000000	63.000000	61.000000	30.000000	30.000000	55.000000	55.000000	120.000000	72.000000	0.000000
60	0.000000	0.000000	0.000000	45.000000	55.000000	50.000000	1.000000	0.100000	0.000000	1.000000
70	0.000000	0.000000	0.000000	0.000000	0.000000	0.000000	0.000000	0.000000	0.000000	0.000000
80	0.000000	0.000000	0.000000	0.000000	0.000000	0.000000	0.000000	0.000000	0.000000	0.000000
90	500.000000	10.000000	0.000000	0.000000	90.000000	0.000000	0.000000	80.000000	55.000000	0.000000
100	0.000000	0.000000	0.000000	0.000000	0.000000	0.000000	0.000000	0.000000	0.000000	0.000000
110	0.000000	-1.000000	55.000000	120.000000	75.000000	75.000000	70.000000	70.000000	0.000000	0.000000

4. If a Data Array table returns only zeros (see the image below), the PT-Link is not communicating with the selected controller. See **Troubleshooting, page 75**.

Offset	0	1	2	3	4	5	6	7	8	9
0	0	0	0	0	0	0	0	0	0	0
10	0	0	0	0	0	0	0	0	0	0
20	0	0	0	0	0	0	0	0	0	0
30	0	0	0	0	0	0	0	0	0	0
40	0	0	0	0	0	0	0	0	0	0
50	0	0	0	0	0	0	0	0	0	0
60	0	0	0	0	0	0	0	0	0	0
70	0	0	0	0	0	0	0	0	0	0
80	0	0	0	0	0	0	0	0	0	0
90	0	0	0	0	0	0	0	0	0	0
100	0	0	0	0	0	0	0	0	0	0
110	0	0	0	0	1	0	0	0	0	0

Addressing Devices in a BACnet Network

Addressing Devices in a BACnet Network

Each PT-Link generates only one BACnet device regardless of the number of AAON controllers connected to it.

This device has all of the properties of all the AAON controllers connected to it.

The instance of the device is equal to the unit address. The properties of each control can be differentiated by an offset of 500.

- Properties of the controller address 1 are 0 to 499.
- Properties of the controller address 2 are 500 to 999.
- Properties of the controller address 3 are 1000 to 1499.
- Properties of the controller address as 4 are 1500 to 1999.

To search for the instance of a specific property, follow this formula:

$$\text{Property Instance} = ((\text{Controller Address} - 1) * 500) + \text{Instance Number from table.}$$

For example:

The PT-Link II BACnet has a Node ID equal to 5. Two VCM controllers are connected and addressed as 1 and 4. The user is searching for the BACnet point for the Outdoor Air Temperature of each controller. The Instance of the Outdoor Air Temperature in the BACnet Properties and PT-Link Data Array Cross Reference table (pages 68-73 for the VCM Controller) is AI: 54. User only sees Device 5. Under Device 5, the user sees AI: 54 for the controller addressed as 1 and AI: 1554 for the controller addressed as 4.

$$\text{Property Instance} = ((\text{Controller Address} - 1) * 500) + \text{Instance Number from table}$$

VCM Controller 1

$$\begin{aligned} &(1 - 1) * 500 + 54 \\ &0 * 500 + 54 \\ &0 + 54 \\ &54 = \text{Property Instance} \end{aligned}$$

VCM Controller 4

$$\begin{aligned} &(4 - 1) * 500 + 54 \\ &3 * 500 + 54 \\ &1500 + 54 \\ &1554 = \text{Property Instance} \end{aligned}$$

NOTE: To simplify the calculation, we recommend that the AAON controllers be addressed in sequential order from one to the last controller with no unused address(es) in between.

Map Descriptors

Users can also use the GUI to discover instances. For example, in the window below, to discover the Cooling Setpoint of a controller, locate the controller and BACnet abbreviation in the Map Descriptors Navigation Window.

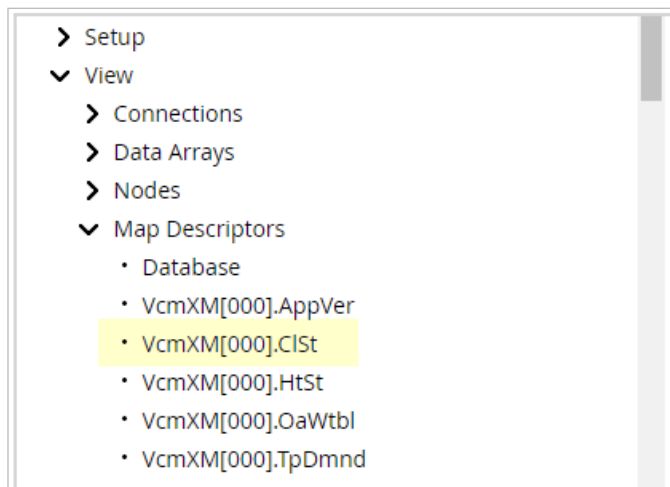

VcmXM[000].ClSt = VCM-x address 1

VcmXM[001].ClSt = VCM-x address 2

VcmXM[002].ClSt = VCM-x address 3

VcmXM[003].ClSt = VCM-x address 4

The Map Descriptor highlighted above is the Cooling Setpoint for the VCM-X Controller address 1.

BACNET AND DATA ARRAY INFORMATION

Data Arrays

Finding BACnet Information

- To cross reference the Data Array information to the BACnet Properties, identify the Data Array Block in the **Data Array** table by adding the number on the Y axis (row) to the number for the X axis (column). For example, in the table below, Y:0 plus X:2 equals 002. The data in this block is 61.000000.

DA_C163_10						
Data Array						
Data Array Attrib						
Name						
Data Array Name	DA_C163_10					
Data Format	Float					
Length in Items	131					
Bytes per Item	4					
Data Age	1.410s					
Display Format						
Float						
Data Array						
Offset	0	1	2	3	4	5
0	164.000000	63.000000	61.000000	0.000000	0.000000	76.400000
10	0.000000	2.000000	2.000000	1.000000	0.000000	0.000000
20	0.000000	1.000000	0.000000	0.000000	10.000000	100.000000
30	0.000000	0.000000	0.000000	0.000000	0.000000	0.000000
40	0.000000	0.000000	0.000000	76.599998	0.000000	50.000000
50	0.000000	63.000000	61.000000	30.000000	30.000000	55.000000

- Look up the BACnet Properties and PT-Link Data Array Cross Reference table for the specific controller (VCM-X in this example). Data Array Block 002 is the Occupied Mode Enable Heating Setpoint Mirror (HtSt, AI: 31).

BACNET PROPERTIES AND PT-LINK DATA ARRAY CROSS REFERENCE FOR VCM-X						
Parameter	Data Array Block	Name	Object	Description	Limits	
Application Software Version	000 (0:0)	AppVer	AI: 99	Current version of the software in the unit.		
Occupied Mode Enable Cooling Setpoint Mirror	001 (0:1)	CISt	AI: 7	Occupied Mode Enable Cooling Setpoint Mirror.		
Occupied Mode Enable Heating Setpoint Mirror	002 (0:2)	HtSt	AI: 31	Occupied Mode Enable Heating Setpoint Mirror.		

BACNET AND DATA ARRAY INFORMATION

VCCX2 Controller

BACnet Properties and PT-Link Data Array Cross Reference

BACNET PROPERTIES AND PT-LINK DATA ARRAY CROSS REFERENCE FOR VCCX2					
Parameter	Data Array Block	Name	Object	Description	Limits
Application Software Version	000 (0:0)	AppVer	AI: 99	Current version of the software in the unit.	
Control Mode	001 (0:1)	CtrlMod	AI: 97	Configured unit application.	See Control Mode Bits on page 39.
Control Status	002 (0:2)	CtrlSts	AI: 4	Current occupied/unoccupied status.	See Control Status Bits on page 39.
Hvac Mode	003 (0:3)	HvacMode	AI: 175	Current operational status.	See HVAC Mode Bits on page 39.
Control Temperature	004 (0:4)	CtrlTp	AI: 9	Current value of the Control Temperature Sensor.	
Mode Cooling Setpoint	005 (0:5)	ClSt	AI: 7	Cooling Mode Enable Setpoint Mirror (adjusted by the Space Sensor slide adjustment and/or night setback offsets).	
Mode Heating Setpoint	006 (0:6)	HtSt	AI: 31	Heating Mode Enable Setpoint Mirror (adjusted by the Space Sensor slide adjustment and/or night setback offsets).	
Sensor Slide Adjust Effect	007 (0:7)	SldAdOfs	AI: 338	Amount of current sensor slide offset.	
Supply Air Temperature	008 (0:8)	SaTp	AI: 83	Current value of the Supply Air Temperature Sensor.	
Supply Air Setpoint	009 (0:9)	SaTpSt	AI: 81	Current SAT Cooling or Heating Setpoint if there is no reset source. Current calculated SAT Setpoint with reset source.	
Controlling Coil Temp Setpoint	010 (10:0)	CoilTpSt	AI: 334	This is the current calculated Coil Suction Temperature target during Dehumidification Mode.	
Space Temperature	011 (10:1)	SpcTp	AI: 72	Current value of the Space Temperature Sensor.	
Space Humidity	012 (10:2)	InRh	AI: 67	Current value of the space humidity.	
Return Air Temperature	013 (10:3)	RaTp	AI: 64	Current value of the Return Temperature Sensor.	
Return Air Humidity	014 (10:4)	RaRH	AI: 337	Current value of the return air humidity.	
Outdoor Air Temperature	015 (10:5)	OaTp	AI: 54	Current value of the Outdoor Air Temperature Sensor.	
Outdoor Air Humidity	016 (10:6)	OaRh	AI: 52	Current value of the Outdoor Humidity Sensor.	
Outdoor Air Wetbulb	017 (10:7)	OaWtbl	AI: 55	Current calculated Outdoor Wetbulb Temperature.	
Outdoor Air Dewpoint	018 (10:8)	OaDewPt	AI: 332	Current calculated Outdoor Air Dewpoint Temperature.	
Supply Air Setpoint Reset Voltage	019 (10:9)	SaStRt	AI: 290	Supply Air Temp Setpoint reset input dignal	
Duct Static Pressure	020 (20:0)	DuctPr	AI: 14	Current duct static pressure.	

Objects labeled AI and BI are read-only. Objects labeled AV are read/write. Objects labeled AV are read/write. Sensor Inputs are read-only.

BACNET AND DATA ARRAY INFORMATION

VCCX2 Controller

BACNET PROPERTIES AND PT-LINK DATA ARRAY CROSS REFERENCE FOR VCCX2						
Parameter	Data Array Block	Name	Object	Description	Limits	
Duct Static Control Signal	021 (20:1)	FanVfdSg	AI: 292	Current duct static control signal (fan VFD).		
Building Pressure	022 (20:2)	BuildPr	AI: 272	Current value of the Building Pressure Sensor.		
Building Pressure Control Signal	023 (20:3)	RlfSgl	AI: 293	Current building pressure control signal.		
Outdoor Airflow	024 (20:4)	OaCFM	AI: 193	Current outdoor airflow measurement.		
Supply Airflow	025 (20:5)	SaCFM	AI: 195	Current supply airflow measurement.		
Return Airflow	026 (20:6)	RaCFM	AI: 275	Current return airflow measurement.		
Exhaust Airflow	027 (20:7)	EtCFM	AI: 194	Current exhaust airflow measurement.		
Carbon Dioxide	028 (20:8)	CO2	AI: 271	Current indoor CO ₂ level.		
Desired Economizer Position	029 (20:9)	EcoPos	AI: 16	Current modulating signal to the economizer damper.		
Economizer Feedback Position	030 (30:0)	T24EcFb	AI: 384	Title 24 current position of feedback from economizer actuator.		
Return Damper Position	031 (30:1)	RaDmp	AI: 154	Current signal to the return air damper if using return air bypass.		
Return Bypass Position	032 (30:2)	RetBydmp	AI: 335	Current signal to the return air bypass damper if using return air bypass.		
Modulating Cooling Position	033 (30:3)	MdClSgl	AI: 294	Current percentage of the modulating chilled water signal.		
Modulating Heat Position	034 (30:4)	MdHtSgl	AI: 295	Current percentage of the modulating heating signal (hot water or SCR heat).		
Mod Hot Gas Reheat Valve Position	035 (30:5)	Rt2Pos	AI: 60	Current position of MHGRV Modulating Hot Gas Reheat Valve.		
Mod Gas Heat Valve Position	036 (30:6)	MdGsVPos	AI: 274	Current position of MODGAS Modulating Gas Valve Control.		
A1 Compressor Signal	037 (30:7)	A1Cmpr	AI: 400	Current Compressor A1 modulating cooling signal.		
A2 Compressor Signal	038 (30:8)	A2Cmpr	AI: 401	Current Compressor A2 modulating cooling signal.		
A1 Condenser Signal	039 (30:9)	A1Cndr	AI: 402	Current A1 Condenser signal.		
A2 Condenser Signal	040 (40:0)	A2Cndr	AI: 403	Current A2 Condenser signal.		
A1 Suction Pressure	041 (40:1)	A1SucPr	AI: 404	Current Compressor A1 suction pressure.		
A2 Suction Pressure	042 (40:2)	A2SucPr	AI: 405	Current Compressor A2 suction pressure.		
A1 Head Pressure	043 (40:3)	A1HdPr	AI: 406	Current Compressor A1 head pressure.		
A2 Head Pressure	044 (40:4)	A2HdPr	AI: 407	Current Compressor A2 head pressure.		
Objects labeled AI and BI are read-only. Objects labeled AV are read/write. Objects labeled AV are read/write. Sensor Inputs are read-only.						

BACNET AND DATA ARRAY INFORMATION

VCCX2 Controller

BACNET PROPERTIES AND PT-LINK DATA ARRAY CROSS REFERENCE FOR VCCX2

Parameter	Data Array Block	Name	Object	Description	Limits	
A1 Saturation Temperature	045 (40:5)	A1SauTp	AI: 408	Current Compressor A1 Coil Saturation Temperature.		
A2 Saturation Temperature	046 (40:6)	A2SauTp	AI: 409	Current Compressor A2 Coil Saturation Temperature.		
A1 Suction Line Temperature	047 (40:7)	A1SucTp	AI: 410	Current Compressor A1 Suction Line Temperature.		
A2 Suction Line Temperature	048 (40:8)	A2SucTp	AI: 411	Current Compressor A2 Suction Line Temperature.		
A1 Superheat Temperature	049 (40:9)	A1SupHt	AI: 412	Current Compressor A1 Superheat Temperature.		
A2 Superheat Temperature	050 (50:0)	A2SupHt	AI: 413	Current Compressor A2 Superheat Temperature.		
A1 Expansion Valve Position	051 (50:1)	A1ExpVv	AI: 414	Current position of Compressor A1 expansion valve.		
A2 Expansion Valve Position	052 (50:2)	A2ExpVv	AI: 415	Current position of Compressor A2 expansion valve.		
A1 Discharge Temperature	053 (50:3)	A1DscTp	AI: 416	Current Compressor A1 Discharge Temperature.		
A2 Discharge Temperature	054 (50:4)	A2DscTp	AI: 417	Current Compressor A2 Discharge Temperature.		
A1 Leaving Water Temp	055 (50:5)	ALevWtr	AI: 418	Current A1 Leaving Water Temperature for WSHP.		
B1 Compressor Signal	056 (50:6)	B1Cmpr	AI: 430	Current Compressor B1 modulating cooling signal.		
B2 Compressor Signal	057 (50:7)	B2Cmpr	AI: 431	Current Compressor B2 modulating cooling signal.		
B1 Condenser Signal	058 (50:8)	B1Cndr	AI: 432	Current B1 Condenser signal.		
B2 Condenser Signal	059 (50:9)	B2Cndr	AI: 433	Current B2 Condenser signal.		
B1 Suction Pressure	060 (60:0)	B1SucPr	AI: 434	Current Compressor B1 suction pressure.		
B2 Suction Pressure	061 (60:1)	B2SucPr	AI: 435	Current Compressor B2 suction pressure.		
B1 Head Pressure	062 (60:2)	B1HdPr	AI: 436	Current Compressor B1 head pressure.		
B2 Head Pressure	063 (60:3)	B2HdPr	AI: 437	Current Compressor B2 head pressure.		
B1 Saturation Temperature	064 (60:4)	B1SauTp	AI: 438	Current Compressor B1 Coil Saturation Temperature.		
B2 Saturation Temperature	065 (60:5)	B2SauTp	AI: 439	Current Compressor B2 Coil Saturation Temperature.		
B1 Suction Line Temperature	066 (60:6)	B1SucTp	AI: 440	Current Compressor B1 Suction Line Temperature.		
B2 Suction Line Temperature	067 (60:7)	B2SucTp	AI: 441	Current Compressor B2 Suction Line Temperature.		
B1 Superheat Temperature	068 (60:8)	B1SupHt	AI: 442	Current Compressor B1 Superheat Temperature.		

Objects labeled AI and BI are read-only. Objects labeled AV are read/write. Objects labeled AV are read/write. Sensor Inputs are read-only.

BACNET AND DATA ARRAY INFORMATION

VCCX2 Controller

BACNET PROPERTIES AND PT-LINK DATA ARRAY CROSS REFERENCE FOR VCCX2

Parameter	Data Array Block	Name	Object	Description	Limits
B2 Superheat Temperature	069 (60:9)	B2SupHt	AI: 443	Current Compressor B2 Superheat Temperature.	
B1 Expansion Valve Position	070 (70:0)	B1ExpVv	AI: 444	Current position of Compressor B1 expansion valve.	
B2 Expansion Valve Position	071 (70:1)	B2ExpVv	AI: 445	Current position of Compressor B2 expansion valve.	
B1 Discharge Temperature	072 (70:2)	B1DscTp	AI: 446	Current Compressor B1 Discharge Temperature.	
B2 Discharge Temperature	073 (70:3)	B2DscTp	AI: 447	Current Compressor B2 Discharge Temperature.	
B1 Leaving Water Temperature	074 (70:4)	BLevWtr	AI: 448	Current B1 Leaving Water Temperature for WSHP.	
C1 Compressor Signal	075 (70:5)	C1Cmpr	AI: 460	Current Compressor C1 modulating cooling signal.	
C2 Compressor Signal	076 (70:6)	C2Cmpr	AI: 461	Current Compressor C2 modulating cooling signal.	
C1 Condenser Signal	077 (70:7)	C1Cndr	AI: 462	Current C1 Condenser signal.	
C2 Condenser Signal	078 (70:8)	C2Cndr	AI: 463	Current C2 Condenser signal.	
C1 Suction Pressure	079 (70:9)	C1SucPr	AI: 464	Current Compressor C1 suction pressure.	
C2 Suction Pressure	080 (80:0)	C2SucPr	AI: 465	Current Compressor C2 suction pressure.	
C1 Head Pressure	081 (80:1)	C1HdPr	AI: 466	Current Compressor C1 head pressure.	
C2 Head Pressure	082 (80:2)	C2HdPr	AI: 467	Current Compressor C2 head pressure.	
C1 Saturation Temperature	083 (80:3)	C1SauTp	AI: 468	Current Compressor C1 Coil Saturation Temperature.	
C2 Saturation Temperature	084 (80:4)	C2SauTp	AI: 469	Current Compressor C2 Coil Saturation Temperature.	
C1 Suction Line Temperature	085 (80:5)	C1SucTp	AI: 470	Current Compressor C1 Suction Line Temperature.	
C2 Suction Line Temperature	086 (80:6)	C2SucTp	AI: 471	Current Compressor C2 Suction Line Temperature.	
C1 Superheat Temperature	087 (80:7)	C1SupHt	AI: 472	Current Compressor C1 Superheat Temperature.	
C2 Superheat Temperature	088 (80:8)	C2SupHt	AI: 473	Current Compressor C2 Superheat Temperature.	
C1 Expansion Valve Position	089 (80:9)	C1ExpVv	AI: 474	Current position of Compressor C1 expansion valve.	
C2 Expansion Valve Position	090 (90:0)	C2ExpVv	AI: 475	Current position of Compressor C2 expansion valve.	
C1 Discharge Temperature	091 (90:1)	C1DscTp	AI: 476	Current Compressor C1 Discharge Temperature.	
C2 Discharge Temperature	092 (90:2)	C2DscTp	AI: 477	Current Compressor C2 Discharge Temperature.	

Objects labeled AI and BI are read-only. Objects labeled AV are read/write. Objects labeled AV are read/write. Sensor Inputs are read-only.

BACNET AND DATA ARRAY INFORMATION

VCCX2 Controller

BACNET PROPERTIES AND PT-LINK DATA ARRAY CROSS REFERENCE FOR VCCX2

Parameter	Data Array Block	Name	Object	Description	Limits
C1 Leaving Water Temp	093 (90:3)	CLevWtr	AI: 478	Current C1 Leaving Water Temperature for WSHP.	
D1 Compressor Signal	094 (90:4)	D1Cmpr	AI: 200	Current Compressor D1 modulating cooling signal.	
D2 Compressor Signal	095 (90:5)	D2Cmpr	AI: 201	Current Compressor D2 modulating cooling signal.	
D1 Condenser Signal	096 (90:6)	D1Cndr	AI: 202	Current D1 Condenser signal.	
D2 Condenser Signal	097 (90:7)	D2Cndr	AI: 203	Current D2 Condenser signal.	
D1 Suction Pressure	098 (90:8)	D1SucPr	AI: 204	Current Compressor D1 suction pressure.	
D2 Suction Pressure	099 (90:9)	D2SucPr	AI: 205	Current Compressor D2 suction pressure.	
D1 Head Pressure	100 (100:0)	D1HdPr	AI: 206	Current Compressor D1 head pressure.	
D2 Head Pressure	101 (100:1)	D2HdPr	AI: 207	Current Compressor D2 head pressure.	
D1 Saturation Temperature	102 (100:2)	D1SauTp	AI: 208	Current Compressor D1 Coil Saturation Temperature.	
D2 Saturation Temperature	103 (100:3)	D2SauTp	AI: 209	Current Compressor D2 Coil Saturation Temperature.	
D1 Suction Line Temperature	104 (100:4)	D1SucTp	AI: 210	Current Compressor D1 Suction Line Temperature.	
D2 Suction Line Temperature	105 (100:5)	D2SucTp	AI: 211	Current Compressor D2 Suction Line Temperature.	
D1 Superheat Temperature	106 (100:6)	D1SupHt	AI: 212	Current Compressor D1 Superheat Temperature.	
D2 Superheat Temperature	107 (100:7)	D2SupHt	AI: 213	Current Compressor D2 Superheat Temperature.	
D1 Expansion Valve Position	108 (100:8)	D1ExpVv	AI: 214	Current position of Compressor D1 expansion valve.	
D2 Expansion Valve Position	109 (100:9)	D2ExpVv	AI: 215	Current position of Compressor D2 expansion valve.	
D1 Discharge Temperature	110 (110:0)	D1DscTp	AI: 216	Current Compressor D1 Discharge Temperature.	
D2 Discharge Temperature	111 (110:1)	D2DscTp	AI: 217	Current Compressor D2 Discharge Temperature.	
D1 Leaving Water Temperature	112 (110:2)	DLevWtr	AI: 218	Current D1 Leaving Water Temperature for WSHP.	
Alarm Status	113 (110:3)	AlmSts	AI: 1	Indicates an alarm condition.	0 = No alarms 1 = Alarm(s) present
Preheater Leaving Air Temp #1	114 (110:4)	PrHtLv1	AI: 296	Current preheater Leaving Air Temperature #1.	
Preheater Leaving Air Temp #2	115 (110:5)	PrHtLv2	AI: 297	Current preheater Leaving Air Temperature #2.	
Preheater Entering Air Temp	116 (110:6)	PrHtEnt	AI: 298	Current Entering Air Temperature for preheater.	

Objects labeled AI and BI are read-only. Objects labeled AV are read/write. Objects labeled AV are read/write. Sensor Inputs are read-only.

BACNET AND DATA ARRAY INFORMATION

VCCX2 Controller

BACNET PROPERTIES AND PT-LINK DATA ARRAY CROSS REFERENCE FOR VCCX2						
Parameter	Data Array Block	Name	Object	Description	Limits	
Preheater Setpoint Reset Voltage	117 (110:07)	PrHtRst	AI: 299	Current voltage reset input value for preheater.		
Preheater SCR Output Signal	118 (110:8)	PrHtScr	AI: 300	Current modulating heat signal for preheater.		
Preheater PWM Output Signal	119 (110:9)	PrHtPwm	AI: 301	Current PWM output signal for preheater.		
Cooling Enabled Status	120 (120:0)	CIEnbl	BI: 6	Status indicates mechanical cooling is enabled based on the cooling lockout.		
Heating Enabled Status	121 (120:1)	HtEnbl	BI: 30	Status indicates mechanical heating is enabled based on the heating lockout.		
Economizer Enabled Status	122 (120:2)	EcoEnbl	BI: 15	Status indicates the economizer is enabled based on the Economizer Enable Setpoint.		
Aux Heat Enabled Status	123 (120:3)	AuxHtEn	BI: 305	Heat pump auxiliary heat enabled.		
Emergency Heat Enabled Status	124 (120:4)	EmHtEnbl	BI: 364	Shows the emergency heat is enabled based on the compressor heating lockout.		
Fan Proof of Airflow Status	125 (120:5)	Pof	BI: 56	Proof of airflow binary input status.		
Exhaust Hood On/Off Status	126 (120:6)	EtHood	BI: 306	Exhaust hood on/off binary input status.		
Remote Forced Occupied Status	127 (120:7)	RmOc	BI: 307	Remote forced occupied mode binary input status.		
Remote Forced Cooling Status	128 (120:8)	RmCl	BI: 308	Remote forced cooling mode binary input status.		
Remote Forced Heating Status	129 (120:9)	RmHt	BI: 309	Remote forced heating mode binary input status.		
Remote Force Dehum Status	130 (130:0)	RmDhum	BI: 310	Remote force Dehumidification Mode binary input status.		
Bad Supply Air Sensor	131 (130:1)	SaTpAlm	BI: 2	Alarm that indicates a failure of the Supply Air Sensor.		
Bad Return Air Sensor	132 (130:2)	RaTpAlm	BI: 365	Alarm that indicates a failure of the Return Air Sensor.		
Bad Outdoor Air Sensor	133 (130:3)	OaTpAlm	BI: 311	Failure of the Outdoor Air Temperature Sensor.		
Bad Space Temp Sensor	134 (130:4)	SpcTpAlm	BI: 101	Failure of the Space Temperature Sensor. If space is the controlling sensor, the unit will shut down.		
Bad Carbon Dioxide Sensor	135 (130:5)	CO2Alm	BI: 368	Failure of the CO ₂ Sensor.		
Bad Building Pressure Sensor	136 (130:6)	RefAlm	BI: 312	Alarm indicating missing or failed Building Pressure Sensor.		
Bad Outdoor Airflow Sensor	137 (130:7)	OaCfmAlm	BI: 370	An Outdoor Airflow Sensor is configured, but not detected.		
Bad Exhaust Airflow Sensor	138 (130:8)	EaCfmAlm	BI: 313	An Exhaust Airflow Sensor is configured, but not detected.		
Bad Supply Airflow Sensor	139 (130:9)	SaCfmAlm	BI: 372	A Supply Airflow Sensor is configured, but not detected.		

Objects labeled AI and BI are read-only. Objects labeled AV are read/write. Objects labeled AV are read/write. Sensor Inputs are read-only.

BACNET AND DATA ARRAY INFORMATION

VCCX2 Controller

BACNET PROPERTIES AND PT-LINK DATA ARRAY CROSS REFERENCE FOR VCCX2						
Parameter	Data Array Block	Name	Object	Description	Limits	
Bad Return Airflow Sensor	140 (140:0)	RaCfmAlm	BI: 373	A Return Airflow Sensor is configured, but not detected.		
Mechanical Cooling Alarm	141 (140:1)	CIAlm	BI: 314	Compressor relays are enabled but the Supply Air Temperature has not fallen 5°F within a user-adjustable time period. This does not apply to modulating cooling.		
Mechanical Heating Alarm	142 (140:2)	HtAlm	BI: 315	Heating Mode has been initiated but the Supply Air Temperature has not risen 5°F within a user-adjustable time period. Alarms on the MODGAS-X and Preheat-X Controller will generate this alarm. This alarm does not apply to modulating hot water or steam heating.		
Fan Proving Alarm	143 (140:3)	FanAlm	BI: 316	Alarm indicates an airflow failure from the main fan. Heating and cooling will be disabled.		
Dirty Filter Alarm	144 (140:4)	DrtFIAIm	BI: 96	Alarm indicates the filters are dirty.		
Emergency Shutdown Alarm	145 (140:5)	EmerAlm	BI: 219	Alarm indicates emergency shutdown has been activated. Will shut the unit down.		
Relay Runtime Warning	146 (140:6)	RIRnTm	BI: 317	Indicates when any of the configured relays exceeds a configured number of hours of runtime. Can be used to schedule service, etc.		
Economizer Missing Alarm	147 (140:7)	EcoMs	BI: 318	Title 24 operation indicates missing economizer feedback.		
Economizer Title 24 Failure A	148 (140:8)	EcoFIA	BI: 231	Title 24 Air Temperature Sensor failure.		
Economizer Title 24 Failure B	149 (140:9)	EcoFIB	BI: 232	Title 24 not economizing when it should.		
Economizer Title 24 Failure C	150 (150:0)	EcoFIC	BI: 234	Title 24 economizing when it should not.		
Economizer Title 24 Failure D	151 (150:1)	EcoFID	BI: 235	Title 24 damper not modulating.		
Economizer Title 24 Failure E	152 (150:2)	EcoFIE	BI: 236	Title 24 excess outdoor air.		
High Supply Temp Cutoff	153 (150:3)	HiCfAlm	BI: 237	Alarm generates when the supply air has risen above the High SAT Cutoff Setpoint. Heating stages will deactivate and the fan continues to run.		
Low Supply Temp Cutoff	154 (150:4)	LoCfAlm	BI: 238	The supply air has fallen below the Low SAT Cutoff Setpoint. Cooling stages will deactivate. After 10 minutes, the fan will deactivate and this alarm is generated.		
High Control Mode Alarm	155 (150:5)	HiMdAlm	BI: 239	Occurs when the controlling sensor temperature rises above the Cooling Mode Enable Setpoint plus the Control Mode High Alarm Offset. Applies only to Space or Return Air Temperature controlled units.		

Objects labeled AI and BI are read-only. Objects labeled AV are read/write. Objects labeled AV are read/write. Sensor Inputs are read-only.

BACNET AND DATA ARRAY INFORMATION

VCCX2 Controller

BACNET PROPERTIES AND PT-LINK DATA ARRAY CROSS REFERENCE FOR VCCX2

Parameter	Data Array Block	Name	Object	Description	Limits
Low Control Mode Alarm	156 (150:6)	LoMdAlm	BI: 240	Occurs when the controlling sensor temperature falls below the Heating Mode Enable Setpoint minus the Control Mode Low Alarm Offset. Applies only to Space or Return Air Temperature controlled units.	
Preheater Alarm	157 (150:7)	PreHtAlm	BI: 258	Preheater alarm indicator.	
Missing Refrigerant Module #1	158 (150:8)	BadMod1	BI: 241	Refrigerant Module #1 is bad or missing.	
Missing Refrigerant Module #2	159 (150:9)	BadMod2	BI: 242	Refrigerant Module #2 is bad or missing.	
Missing Refrigerant Module #3	160 (160:0)	BadMod3	BI: 243	Refrigerant Module #3 is bad or missing.	
Missing Refrigerant Module #4	161 (160:1)	BadMod4	BI: 244	Refrigerant Module #4 is bad or missing.	
Missing Preheater Board	162 (160:2)	BadPreBd	BI: 245	Preheater Module is bad or missing.	
Missing Reheat Board	163 (160:3)	BadRhtBd	BI: 246	The MHGR board is configured but not detected.	
Missing Mod Gas Board	164 (160:4)	BadMgsBd	BI: 247	The MODGAS board is configured but not detected.	
Missing EM1 Board	165 (160:5)	BadEm1Bd	BI: 248	EM1 Expansion Board is bad or missing.	
Missing 12 Relay Expansion Board	166 (160:6)	BadExRly	BI: 249	The 12 Relay Expansion Board is configured but not detected.	
On Board Relay 1 Main Fan	167 (160:7)	OnRly1	BI: 127	Current status of Main Fan Relay #1 on main board.	
On Board Relay 2	168 (160:8)	OnRly2	BI: 128	Current status of Configurable Relay #2 on main board.	
On Board Relay 3	169 (160:9)	OnRly3	BI: 129	Current status of Configurable Relay #3 on main board.	
On Board Relay 4	170 (170:0)	OnRly4	BI: 130	Current status of Configurable Relay #4 on main board.	
On Board Relay 5	171 (170:1)	OnRly5	BI: 131	Current status of Configurable Relay #5 on main board.	
On Board Relay 6	172 (170:2)	OnRly6	BI: 259	Current status of Configurable Relay #6 on main board.	
On Board Relay 7	173 (170:3)	OnRly7	BI: 250	Current status of Configurable Relay #7 on main board.	
On Board Relay 8	174 (170:4)	OnRly8	BI: 251	Current status of Configurable Relay #8 on main board.	
Expansion Board EM1 Relay 1	175 (170:5)	Em1Rly1	BI: 252	Current status of Configurable Relay #1 on EM1 Board.	
Expansion Board EM1 Relay 2	176 (170:6)	Em1Rly2	BI: 253	Current status of Configurable Relay #2 on EM1 Board.	
Expansion Board EM1 Relay 3	177 (170:7)	Em1Rly3	BI: 254	Current status of Configurable Relay #3 on EM1 Board.	
Expansion Board EM1 Relay 4	178 (170:8)	Em1Rly4	BI: 256	Current status of Configurable Relay #4 on EM1 Board.	

Objects labeled AI and BI are read-only. Objects labeled AV are read/write. Objects labeled AV are read/write. Sensor Inputs are read-only.

BACNET AND DATA ARRAY INFORMATION

VCCX2 Controller

BACNET PROPERTIES AND PT-LINK DATA ARRAY CROSS REFERENCE FOR VCCX2						
Parameter	Data Array Block	Name	Object	Description	Limits	
Expansion Board EM1 Relay 5	179 (170:9)	Em1Rly5	BI: 257	Current status of Configurable Relay #5 on EM1 Board.		
12 Relay Expansion Board Relay 1	180 (180:0)	ExRly1	BI: 133	Current status of Configurable Relay #1 on 12 Relay Board.		
12 Relay Expansion Board Relay 2	181 (180:1)	ExRly2	BI: 134	Current status of Configurable Relay #2 on 12 Relay Board.		
12 Relay Expansion Board Relay 3	182 (180:2)	ExRly3	BI: 135	Current status of Configurable Relay #3 on 12 Relay Board.		
12 Relay Expansion Board Relay 4	183 (180:3)	ExRly4	BI: 136	Current status of Configurable Relay #4 on 12 Relay Board.		
12 Relay Expansion Board Relay 5	184 (180:4)	ExRly5	BI: 137	Current status of Configurable Relay #5 on 12 Relay Board.		
12 Relay Expansion Board Relay 6	185 (180:5)	ExRly6	BI: 138	Current status of Configurable Relay #6 on 12 Relay Board.		
12 Relay Expansion Board Relay 7	186 (180:6)	ExRly7	BI: 139	Current status of Configurable Relay #7 on 12 Relay Board.		
12 Relay Expansion Board Relay 8	187 (180:7)	ExRly8	BI: 140	Current status of Configurable Relay #8 on 12 Relay Board.		
12 Relay Expansion Board Relay 9	188 (180:8)	ExRly9	BI: 141	Current status of Configurable Relay #9 on 12 Relay Board.		
12 Relay Expansion Board Relay 10	189 (180:9)	ExRly10	BI: 142	Current status of Configurable Relay #10 on 12 Relay Board.		
12 Relay Expansion Board Relay 11	190 (190:0)	ExRly11	BI: 143	Current status of Configurable Relay #11 on 12 Relay Board.		
12 Relay Expansion Board Relay 12	191 (190:1)	ExRly12	BI: 144	Current status of Configurable Relay #12 on 12 Relay Board.		
Preheater Enable Status	192 (190:2)	PreHtEn	BI: 302	Status of preheater enable input.		
Preheater Emergency Shutdown	193 (190:3)	PreHtEm	BI: 303	Status of preheater emergency shutdown input.		
Preheater Spare Binary Input #3	194 (190:4)	PreHtBi3	BI: 304	Status of preheater binary input #3.		
MODGAS Enable Status	195 (190:5)	MdGsEn	BI: 257	Status of MODGAS Controller.		
MHGR Enable Status	196 (190:6)	RehtEnbl	BI: 363	Status of MHGRV Controller.		
A1 Compressor Enable	197 (190:7)	A1CmpEn	BI: 419	Current status of enable signal to Compressor A1.		
A2 Compressor Enable	198 (190:8)	A2CmpEn	BI: 420	Current status of enable signal to Compressor A2.		
A1 Compressor Alarms	199 (190:9)	A1Alm	BI: 421	Indicates an RSM alarm is present on the A1 circuit.		
A2 Compressor Alarms	200 (200:0)	A2Alm	BI: 422	Indicates an RSM alarm is present on the A2 circuit.		
A1-2 Defrost Switch	201 (200:1)	ADfrSw	BI: 423	Outdoor coil A1/A2 temp switch for Defrost Mode.		
A1-2 Water Proof of Flow	202 (200:2)	AWtrPf	BI: 424	A1/A2 water proof of flow switch.		
Objects labeled AI and BI are read-only. Objects labeled AV are read/write. Objects labeled AV are read/write. Sensor Inputs are read-only.						

BACNET AND DATA ARRAY INFORMATION

VCCX2 Controller

BACNET PROPERTIES AND PT-LINK DATA ARRAY CROSS REFERENCE FOR VCCX2

Parameter	Data Array Block	Name	Object	Description	Limits	
Refrigerant Module 1 Relay 1	203 (200:3)	M1Rly1	BI: 425	Current status of Compressor A1 enable relay.		
Refrigerant Module 1 Relay 2	204 (200:4)	M1Rly2	BI: 426	Current status of Compressor A2 enable relay.		
Refrigerant Module 1 Relay 3	205 (200:5)	M1Rly3	BI: 427	Current status of Condenser 1 enable relay.		
Refrigerant Module 1 Relay 4	206 (200:6)	M1Rly4	BI: 428	Current status of Relay #4.		
Refrigerant Module 1 Relay 5	207 (200:7)	M1Rly5	BI: 429	Current status of Relay #5.		
B1 Compressor Enable	208 (200:8)	B1CmpEn	BI: 449	Current status of enable signal to Compressor B1.		
B2 Compressor Enable	209 (200:9)	B2CmpEn	BI: 450	Current status of enable signal to Compressor B2.		
B1 Compressor Alarms	210 (210:0)	B1Alm	BI: 451	Indicates an RSM alarm is present on the B1 circuit.		
B2 Compressor Alarms	211 (210:1)	B2Alm	BI: 452	Indicates an RSM alarm is present on the B2 circuit.		
B1-2 Defrost Switch	212 (210:2)	BDfrSw	BI: 453	Outdoor coil B1/B2 temp switch for Defrost Mode.		
B1-2 Water Proof of Flow	213 (210:3)	BWtrPf	BI: 454	B1/B2 switch for water proof of flow.		
Refrigerant Module 2 Relay 1	214 (210:4)	M2Rly1	BI: 455	Current status of Compressor 1 enable relay.		
Refrigerant Module 2 Relay 2	215 (210:5)	M2Rly2	BI: 456	Current status of Compressor 2 enable relay.		
Refrigerant Module 2 Relay 3	216 (210:6)	M2Rly3	BI: 457	Current status of Condenser 1 enable relay.		
Refrigerant Module 2 Relay 4	217 (210:7)	M2Rly4	BI: 458	Current status of Relay #4.		
Refrigerant Module 2 Relay 5	218 (210:8)	M2Rly5	BI: 459	Current status of Relay #5.		
C1 Compressor Enable	219 (210:9)	C1CmpEn	BI: 220	Current status of enable signal to Compressor C1.		
C2 Compressor Enable	220 (220:0)	C2CmpEn	BI: 221	Current status of enable signal to Compressor C2.		
C1 Compressor Alarms	221 (220:1)	C1Alm	BI: 222	Indicates an RSM alarm is present on the C1 circuit.		
C2 Compressor Alarms	222 (220:2)	C2Alm	BI: 223	Indicates an RSM alarm is present on the C2 circuit.		
C1-2 Defrost Switch	223 (220:3)	CDfrSw	BI: 224	Outdoor coil C1/C2 temp switch for Defrost Mode.		
C1-2 Water Proof of Flow	224 (220:4)	CWtrPf	BI: 225	C1/C2 switch for water proof of flow.		
Refrigerant Module 3 Relay 1	225 (220:5)	M3Rly1	BI: 485	Current status of Compressor 1 enable relay.		
Refrigerant Module 3 Relay 2	226 (220:6)	M3Rly2	BI: 486	Current status of Compressor 2 enable relay.		

Objects labeled AI and BI are read-only. Objects labeled AV are read/write. Objects labeled AV are read/write. Sensor Inputs are read-only.

BACNET AND DATA ARRAY INFORMATION

VCCX2 Controller

BACNET PROPERTIES AND PT-LINK DATA ARRAY CROSS REFERENCE FOR VCCX2

Parameter	Data Array Block	Name	Object	Description	Limits	
Refrigerant Module 3 Relay 3	227 (220:7)	M3Rly3	BI: 487	Current status Condenser 1 enable relay.		
Refrigerant Module 3 Relay 4	228 (220:8)	M3Rly4	BI: 488	Current status of relay #4.		
Refrigerant Module 3 Relay 5	229 (220:9)	M3Rly5	BI: 489	Current status of relay #5.		
D1 Compressor Enable	230 (230:0)	D1CmpEn	BI: 220	Current status of enable signal to Compressor D1.		
D2 Compressor Enable	231 (230:1)	D2CmpEn	BI: 221	Current status of enable signal to Compressor D2.		
D1 Compressor Alarms	232 (230:2)	D1Alm	BI: 222	Indicates an RSM alarm is present on the D1 circuit.		
D2 Compressor Alarms	233 (230:3)	D2Alm	BI: 223	Indicates an RSM alarm is present on the D2 circuit.		
D1-2 Defrost Switch	234 (230:4)	DDfrSw	BI: 224	Outdoor soil D1/D2 temp switch for Defrost Mode.		
D1-2 Water Proof of Flow	235 (230:5)	DWtrPf	BI: 225	D1/D2 switch for water proof of flow.		
Refrigerant Module 4 Relay 1	236 (230:6)	M4Rly1	BI: 226	Current status of Compressor 1 enable relay.		
Refrigerant Module 4 Relay 2	237 (230:7)	M4Rly2	BI: 227	Current status of Compressor 2 enable relay.		
Refrigerant Module 4 Relay 3	238 (230:8)	M4Rly3	BI: 228	Current status of Condenser 1 enable relay.		
Refrigerant Module 4 Relay 4	239 (230:9)	M4Rly4	BI: 229	Current status of Relay #4.		
Refrigerant Module 4 Relay 5	240 (240:0)	M4Rly5	BI: 230	Current status of Relay #5.		
Occupied Cooling Setpoint	241 (240:1)	OcpClSt	AV: 42	If the control temperature rises one deadband above this setpoint, the control will activate the cooling demand. This setpoint does not determine the mode in occupied operation if the unit is configured for supply air cooling or supply air tempering.	1°F (-17.2°C)	110°F (43.3°C)
Occupied Heating Setpoint	242 (240:2)	OcpHtSt	AV: 43	If the control temperature drops one deadband below this setpoint, the control will activate the heating demand. This setpoint does not determine the mode in occupied operation if the unit is configured for supply air, cooling, or supply air tempering.	1°F (-17.2°C)	110°F (43.3°C)
Hood On Cooling Setpoint	243 (240:3)	OaClSt	AV: 45	This is the Cooling Mode Enable Setpoint used only in Hood On Mode or Space Temperature control of high percentage outdoor air units or VAV tempering.	1°F (-17.2°C)	110°F (43.3°C)
Hood On Heating Setpoint	244 (240:4)	OaHtSt	AV: 46	This is the Heating Mode Enable Setpoint used only in Hood On Mode or Space Temperature control of high percentage outdoor air units or VAV tempering.	1°F (-17.2°C)	110°F (43.3°C)

Objects labeled AI and BI are read-only. Objects labeled AV are read/write. Objects labeled AV are read/write. Sensor Inputs are read-only.

BACNET AND DATA ARRAY INFORMATION

VCCX2 Controller

BACNET PROPERTIES AND PT-LINK DATA ARRAY CROSS REFERENCE FOR VCCX2

Parameter	Data Array Block	Name	Object	Description	Limits	
Unoccupied Cooling Offset	245 (240:5)	UnClOst	AV: 124	During the Unoccupied Mode of operation, this setpoint offsets the Occupied Cooling Setpoint up by this user-adjustable amount. If you do not want cooling to operate during the Unoccupied Mode, use the default setting of 30°F for this setpoint.	0°F (0°C)	30°F (16.6°C)
Unoccupied Heating Offset	246 (240:6)	UnHtOst	AV: 125	During the Unoccupied Mode of operation, this setpoint offsets the Occupied Heating Setpoint down by this user-adjustable amount. If you do not want heating to operate during the Unoccupied Mode, use the default setting of 30°F for this setpoint.	0°F (0°C)	30°F (16.6°C)
Mode Select Deadband	247 (240:7)	MdSelDb	AV: 339	This value is added to and subtracted from the HVAC Mode Setpoints to create a control deadband range.	0°F (0°C)	10°F (5.5°C)
Max Coil Setpoint Reset Limit	248 (240:8)	HiClTpSt	AV: 160	This is the highest the Coil Temperature will be reset to during space humidity reset of the Coil Suction Temperature Setpoint. If no Coil Temperature reset is required, this value should be set the same as the Min Coil Reset Limit.	35°F (1.7°C)	70°F (21.1°C)
Min Coil Setpoint Reset Limit	249 (240:9)	LoClTpSt	AV: 163	This is the lowest that the coil temperature will be reset to during space humidity reset of the Coil Suction Temperature Setpoint. If no Coil Temperature reset is required, this value should be set the same as the Max Coil Reset Limit.	35°F (1.7°C)	70°F (21.1°C)
Supply Air Cooling Setpoint	250 (250:0)	SaClSt	AV: 77	Supply Air Cooling Setpoint. If supply air reset is configured this is the low SAT cooling reset value.	30°F (-1.1°C)	80°F (26.6°C)
Supply Air Heating Setpoint	251 (250:1)	SaHtSt	AV: 78	Supply Air Heating Setpoint. If supply air reset is configured this is the low SAT heating reset value.	40°F (4.5°C)	240°F (115.5°C)
Max SAT Cooling Setpoint Reset Limit	252 (250:2)	SaClRt	AV: 324	If supply air reset is configured, this is the high SAT cooling reset value.	0°F (-17.7°C)	100°F (37.7°C)
Max SAT Heating Setpoint Reset Limit	253 (250:3)	SaHtRt	AV: 325	If supply air reset is configured, this is the high SAT heating reset value.	0°F (-17.7°C)	250°F (121.1°C)
Supply Air Cooling Staging Window	254 (250:4)	SaClSgWd	AV: 166	In Cooling Mode, if the Supply Air Temperature drops below the Active Supply Air Cooling Setpoint minus this staging window, a cooling stage will be deactivated after its minimum run time.	1°F (0.6°C)	30°F (16.6°C)
Supply Air Heating Staging Window	255 (250:5)	SaHtSgWd	AV: 167	In Heating Mode, if the Supply Air Temperature rises above the Active Supply Air Heating Setpoint plus this staging window, a heating stage will be deactivated after its minimum run time.	1°F (0.6°C)	50°F (27.7°C)
Warm-Up Target Temperature	256 (250:6)	WmupSt	AV: 91	If morning warm-up is configured, then upon entering occupied mode, the Warm-Up Mode will be activated if the return air is below this temperature by one degree.	50°F (10°C)	90°F (32.2°C)

Objects labeled AI and BI are read-only. Objects labeled AV are read/write. Objects labeled AV are read/write. Sensor Inputs are read-only.

BACNET AND DATA ARRAY INFORMATION

VCCX2 Controller

BACNET PROPERTIES AND PT-LINK DATA ARRAY CROSS REFERENCE FOR VCCX2

Parameter	Data Array Block	Name	Object	Description	Limits	
Warm-Up Mode Supply Air Setpoint	257 (250:7)	WmupSaSt	AV: 168	During morning warm-up, the Supply Air Temperature will be controlled to this setpoint.	40°F (4.5°C)	240°F (115.5°C)
Cool-Down Mode Supply Air Setpoint	258 (250:8)	ClDnSaSp	AV: 171	During morning cool-down, the Supply Air Temperature will be controlled to this setpoint.	30°F (-1.1°C)	80°F (26.6°C)
Mechanical Cooling Outdoor Air Lockout	259 (250:9)	ClLkOut	AV: 172	Mechanical cooling will be locked out when the Outdoor Air Temperature is below this setpoint.	-30°F (-34.4°C)	100°F (37.7°C)
Mechanical Heating Outdoor Air Lockout	260 (260:0)	HtLkOut	AV: 173	Mechanical heating will be locked out when the Outdoor Air Temperature is above this setpoint.	-30°F (-34.4°C)	150°F (65.5°C)
Low Supply Temp Cutoff Alarm	261 (260:1)	LoSaCuOf	AV: 344	Cooling will be disabled if the Supply Air Temperature falls below this value.	0°F (-17.7°C)	100°F (37.7°C)
High Supply Temp Cutoff Alarm	262 (260:2)	HiSaCuOf	AV: 345	Heating will be disabled if the Supply Air Temperature rises above this value.	0°F (-17.7°C)	250°F (121.1°C)
Preheater Cooling Mode Setpoint	263 (260:3)	PrHtClSt	AV: 174	If the preheater is enabled, and the unit is in the Cooling Mode, this setpoint will be sent to the Preheat-X Controller to control Leaving Air Temperature.	35°F (-17.7°C)	90°F (32.2°C)
Preheater Venting Mode Setpoint	264 (260:4)	PrHtVtSt	AV: 176	If the preheater is enabled, and the unit is in the Vent Mode, this setpoint will be sent to the Preheat-X Controller to control Leaving Air Temperature.	35°F (-17.7°C)	90°F (32.2°C)
Preheater Heating Mode Setpoint	265 (260:5)	PrHtHtSt	AV: 177	If the preheater is enabled, and the unit is in the Heating Mode, this setpoint will be sent to the Preheat-X Controller to control Leaving Air Temperature.	35°F (-17.7°C)	90°F (32.2°C)
Outdoor Air Dewpoint Setpoint	266 (260:6)	DptSt	AV: 13	On an MUA unit, if the OA dewpoint rises above this setpoint, dehumidification is initiated.	35°F (1.7°C)	80°F (26.6°C)
Economizer Enable Setpoint	267 (260:7)	EcoEnbl	AV: 283	The economizer is enabled if the Outdoor Drybulb, Dewpoint, or Wetbulb Temperature falls below this setpoint.	-30°F (-34.4°C)	80°F (26.6°C)
Heat Wheel Defrost Enable Setpoint	268 (260:8)	HtWhDefr	AV: 178	The unit will go into heat wheel defrost if the outdoor air is below this setpoint.	0°F (-17.7°C)	50°F (10°C)
PreHeat Enable Setpoint	269 (260:9)	PreHtSp	AV: 196	If the supply fan is energized this is the temperature at which the preheat relay will activate or the Preheat-X Controller will activate. Operates only in the Occupied Mode.	-30°F (-34.4°C)	70°F (21.1°C)
Sensor Slide Offset Max Effect	270 (270:0)	MaxSlidEf	AV: 179	If your Space Sensor has the optional slide adjustment feature, this is the maximum amount the slide can adjust the current heating and cooling setpoints up or down with full deflection of the slide.	0°F (0°C)	10°F (5.5°C)
Space Sensor Calibration Offset	271 (270:1)	SpcTpOst	AV: 71	If the Space Temperature Sensor is reading incorrectly, use this option to enter an offset temperature to adjust the sensor's temperature.	-100°F (-55.5°C)	100°F (55.5°C)

Objects labeled AI and BI are read-only. Objects labeled AV are read/write. Objects labeled AV are read/write. Sensor Inputs are read-only.

BACNET AND DATA ARRAY INFORMATION

VCCX2 Controller

BACNET PROPERTIES AND PT-LINK DATA ARRAY CROSS REFERENCE FOR VCCX2

Parameter	Data Array Block	Name	Object	Description	Limits	
Supply Air Sensor Calibration Offset	272 (270:2)	SaTpOst	AV: 80	If the Supply Air Temperature Sensor is reading incorrectly, use this option to enter an offset temperature to adjust the sensor's temperature.	-100°F (-55.5°C)	100°F (55.5°C)
Return Air Sensor Calibration Offset	273 (270:3)	RaTpOst	AV: 65	If the Return Temperature Sensor is reading incorrectly, use this option to enter an offset temperature to adjust the sensor's temperature.	-100°F (-55.5°C)	100°F (55.5°C)
Outdoor Air Sensor Calibration Offset	274 (270:4)	OaTpOst	AV: 53	If the Outdoor Temperature Sensor is reading incorrectly, use this option to enter an offset temperature to adjust the sensor's temperature.	-100°F (-55.5°C)	100°F (55.5°C)
Carbon Dioxide Sensor Calibration Offset	275 (270:5)	CO2Ost	AV: 348	If the CO ₂ Sensor is reading incorrectly, use this option to enter an offset value to adjust the sensor's CO ₂ reading.	-500	500
Low Ambient Protection Setpoint	276 (270:6)	LWAmbnt	AV: 285	Temperature at which the low ambient relay will activate in the Occupied or Unoccupied Mode.	-30°F (-34.4°C)	70°F (21.1°C)
SAT Cool Setpoint Reset Source Low Limit	277 (270:7)	LoCIRsSr	AV: 164	If doing Supply Air Setpoint reset, this is the low reset source value in cooling that will correspond to the Supply Air Cool High Reset Setpoint.	-30°F (-34.4°C)	150°F (65.5°C)
SAT Cool Setpoint Reset Source High Limit	278 (270:8)	HiCIRsSr	AV: 161	If doing Supply Air Setpoint reset, this is the high reset source value in cooling that will correspond to the Supply Air Cooling Setpoint (Low Reset).	0°F (-17.7°C)	150°F (65.5°C)
SAT Heat Setpoint Reset Source Low Limit	279 (270:9)	LoHtRsSr	AV: 165	If doing Supply Air Setpoint reset, this is the low reset source value in heating that will correspond to the Supply Air Heating High Reset Setpoint.	-30°F (-34.4°C)	150°F (65.5°C)
SAT Heat Setpoint Reset Source High Limit	280 (280:0)	HiHtRsSr	AV: 162	If doing Supply Air Setpoint reset, this is the high reset source value in heating that will correspond to the Supply Air Heating Setpoint (Low Reset).	0°F (-17.7°C)	150°F (65.5°C)
Control Temperature High Alarm Offset	281 (280:1)	CTpHiAIO	AV: 169	If the temperature of the controlling sensor rises above the Occupied Cooling Setpoint by this value, a high control temp alarm will occur. Only applies if configured for space or return air temp control, or as single zone VAV.	0°F (0°C)	50°F (27.7°C)
Control Temperature Low Alarm Offset	282 (280:2)	CTpLoAIO	AV: 170	If the temperature of the controlling sensor falls below the Occupied Heating Setpoint by this value, a low control temp alarm will occur. Only applies if configured for space or return air temp control, or as single zone VAV.	0°F (0°C)	50°F (27.7°C)
Heat Pump Compressor Heat Lockout	283 (280:3)	HpLkt	AV: 351	Compressor heat will be locked out below this setpoint.	-30°F (-34.4°C)	100°F (37.7°C)
Maximum Main Fan VFD in SZ VAVHeating Mode	284 (280:4)	MaxVfd	AV: 180	In single zone VAV configuration, this is the max fan speed the VFD can modulate up to in Heat Mode.	0	100

Objects labeled AI and BI are read-only. Objects labeled AV are read/write. Objects labeled AV are read/write. Sensor Inputs are read-only.

BACNET AND DATA ARRAY INFORMATION

VCCX2 Controller

BACNET PROPERTIES AND PT-LINK DATA ARRAY CROSS REFERENCE FOR VCCX2

Parameter	Data Array Block	Name	Object	Description	Limits	
Minimum Main Fan VFD in Cooling Mode	285 (280:5)	VFDCiMin	AV: 319	In single zone VAV configuration, this is the fan speed at which the VFD will start when cooling is initiated. In a VAV configuration this is the lowest fan speed allowed in the Cooling Mode. In CAV and MUA configurations this should be set to 100%.	0	100
Minimum Main Fan VFD in Heating Mode	286 (280:6)	VFDHtMin	AV: 320	In single zone VAV configuration, this is the fan speed at which the VFD will start when heating is initiated. In a VAV configuration this is the lowest fan speed allowed in the Heating Mode. In CAV and MUA configurations this should be set to 100%.	0	100
Minimum Main Fan VFD in Vent Mode	287 (280:7)	VFDvtMin	AV: 322	Speed at which the VFD will operate in the Vent Mode in single zone VAV.	0	100
Maximum Economizer in Heating Mode	288 (280:8)	MaxEcoHt	AV: 353	Max position the economizer damper can open to in supply air tempering during Heating Mode. Takes priority over max position in high CO ₂ .	0	100
Minimum Economizer Position	289 (280:9)	MinEco	AV: 182	The minimum position of the outdoor air damper in the Occupied Mode. This can be reset upwards based on indoor CO ₂ levels.	0	100
Maximum Economizer CO ₂ Reset Limit	290 (290:0)	MaxEco	AV: 181	The maximum value the economizer minimum position can be reset up to during CO ₂ override.	0	100
Minimum Carbon Dioxide Setpoint	291 (290:1)	CO2MinLv	AV: 287	This is the threshold CO ₂ level at which the Economizer Min Damper Position Setpoint will begin to be reset higher.	0	2000
Maximum Carbon Dioxide Setpoint	292 (290:2)	CO2MaxLv	AV: 288	This is the CO ₂ level at which the economizer minimum damper position will be reset to the economizer maximum position in high CO ₂ . In between the minimum and maximum CO ₂ levels the economizer minimum damper position will be proportionally reset between the configured minimum damper position and the maximum position in high CO ₂ .	0	2000
Indoor Humidity Setpoint Low Reset Limit	293 (290:3)	InRhLoSt	AV: 183	On indoor controlled (non MUA) units, this is the Humidity Setpoint at which the unit leaves dehumidification. During coil temp reset, this is the lowest Space RH value that corresponds to the High Coil Temp Setpoint.	0	100
Indoor Humidity Setpoint High Reset Limit	294 (290:4)	InRhHiSt	AV: 184	On indoor controlled (non MUA) units, this is the Humidity Setpoint at which the unit initiates dehumidification. During coil temp reset, this is the highest space RH value that corresponds to the Low Coil Temp Setpoint.	0	100
Duct Static Pressure Setpoint	295 (290:5)	DuctPrSt	AV: 152	Current Static Pressure Setpoint.	0.1	3

Objects labeled AI and BI are read-only. Objects labeled AV are read/write. Objects labeled AV are read/write. Sensor Inputs are read-only.

BACNET AND DATA ARRAY INFORMATION

VCCX2 Controller

BACNET PROPERTIES AND PT-LINK DATA ARRAY CROSS REFERENCE FOR VCCX2						
Parameter	Data Array Block	Name	Object	Description	Limits	
Duct Static Pressure Control Deadband	296 (290:6)	DuctPrDb	AV: 357	Value above and below the Duct Static Pressure Setpoint where no control change occurs.	0.01	0.5
Building Pressure Control Setpoint	297 (290:7)	RfPrSt	AV: 118	Building Pressure Setpoint or Exhaust Duct Static Pressure Setpoint.	-0.2	3
Building Pressure Control Deadband	298 (290:8)	RlfPrDb	AV: 358	Value above and below the Building Pressure Setpoint or the Exhaust Duct Static Pressure Setpoint where no control change occurs.	0.01	0.5
Minimum Outdoor CFM Requirement	299 (290:9)	OACfmMin	AV: 291	Minimum Outdoor Airflow CFM Setpoint.	0.10K	200K
Outdoor CFM Control Deadband	300 (300:0)	OaCfmDb	AV: 359	Controls rate of change for damper signal. As OA CFM moves further from setpoint within this window, the damper makes a larger change.	10	1000
Single Zone VAV Fan Speed Integral	301 (300:1)	SZVAVFnl	AV: 360	The integral constant for single zone VAV fan control.	0	10
Relay Run-time Hours Warning Limit	302 (300:2)	RIRnTmLm	AV: 185	If any configured relay's run time exceeds this number of hours of operation, a warning alarm is generated so periodic maintenance can be performed.	0	30000
Cooling Mode Head Pressure Setpoint	303 (300:3)	HdPrCl	AV: 186	Head Pressure Setpoint in the Cooling Mode.	250	450
Dehum Mode Head Pressure Setpoint	304 (300:4)	HdPrDhum	AV: 187	Head Pressure Setpoint in the Dehumidification Mode.	250	450
Superheat Setpoint	305 (300:5)	SupHtSp	AV: 188	Superheat Setpoint.	1°F (1°C)	30°F (17°C)
Schedule Force	307 (300:7)	SchdFrc	AV: 66	0 = Auto (uses controller's schedule) 1 = Forced occupied 2 = Forced unoccupied	0	2
Hvac Mode Override	308 (300:8)	HvacMdOv	AV: 190	Overrides normal controller operation in order to force the unit into this desired mode. Configuring for "Auto" will restore normal unit control of the mode of operation.	0 = Auto 1 = Vent 2 = Cool 3 = Heat 4 = Vent dehumidification. 5 = Cool dehumidification 6 = Heat dehumidification	
Fan VFD Override	309 (300:9)	FanVfdOv	AV: 191	Override to force the VFD to this percentage speed. Configuring "auto" will restore normal unit control of the VFD speed.	0%	100%
Outdoor Air Damper Override	310 (310:0)	EcoOv	AV: 192	Overrides all other outdoor air damper position commands so as to maintain this fixed position. Configuring for "auto" will restore normal unit control of the outdoor air damper/economizer operation.	0%	100%
A1 Condenser Suction Temp (Heat Pump)	311 (310:1)	A1CondST	AI: 260	Current Compressor A1 Suction Line Temperature (heat pump).		
A2 Condenser Suction Temp (Heat Pump)	312 (310:2)	A2CondST	AI: 261	Current Compressor A2 Suction Line Temperature (heat pump).		

Objects labeled AI and BI are read-only. Objects labeled AV are read/write. Objects labeled AV are read/write. Sensor Inputs are read-only.

BACNET AND DATA ARRAY INFORMATION

VCCX2 Controller

BACNET PROPERTIES AND PT-LINK DATA ARRAY CROSS REFERENCE FOR VCCX2

Parameter	Data Array Block	Name	Object	Description	Limits
Condenser A1 Superheat (Heat Pump)	313 (310:3)	A1CondSH	AI: 262	Current Compressor A1 Superheat Temperature (heat pump).	
Condenser A2 Superheat (Heat Pump)	314 (310:4)	A2CondSH	AI: 263	Current Compressor A2 Superheat Temperature (heat pump).	
Condenser A1 Expansion Valve Position	315 (310:5)	A1CondEV	AI: 264	Current position of Condenser A1 expansion valve.	
Condenser A2 Expansion Valve Position	316 (310:6)	A2CondEV	AI: 265	Current position of Condenser A2 expansion valve.	
B1 Condenser Suction Temp (Heat Pump)	317 (310:7)	B1CondST	AI: 266	Current Compressor B1 Suction Line Temperature (heat pump).	
B2 Condenser Suction Temp (Heat Pump)	318 (310:8)	B2CondST	AI: 267	Current Compressor B2 Suction Line Temperature (heat pump).	
Condenser B1 Superheat (Heat Pump)	319 (310:9)	B1CondSH	AI: 268	Current Compressor B1 Superheat Temperature (heat pump).	
Condenser B2 Superheat (Heat Pump)	320 (320:0)	B2CondSH	AI: 269	Current Compressor B2 Superheat Temperature (heat pump).	
Condenser B2 Expansion Valve Position	322 (320:2)	B2CondEV	AI: 381	Current position of Condenser B2 expansion valve.	
C1 Condenser Suction Temp (Heat Pump)	323 (320:3)	C1CondST	AI: 382	Current Compressor C1 Suction Line Temperature (heat pump).	
C2 Condenser Suction Temp (Heat Pump)	324 (320:4)	C2CondST	AI: 383	Current Compressor C2 Suction Line Temperature (heat pump).	
Condenser C1 Superheat (Heat Pump)	325 (320:5)	C1CondSH	AI: 385	Current Compressor C1 Superheat Temperature (heat pump).	
Condenser C2 Superheat (Heat Pump)	326 (320:6)	C2CondSH	AI: 386	Current Compressor C2 Superheat Temperature (heat pump).	
Condenser C1 Expansion Valve Position	327 (320:7)	C1CondEV	AI: 387	Current position of Condenser C1 expansion valve.	
Condenser C2 Expansion Valve Position	328 (320:8)	C2CondEV	AI: 388	Current position of Condenser C2 expansion valve.	
D1 Condenser Suction Temp (Heat Pump)	329 (320:9)	D1CondST	AI: 389	Current Compressor D1 Suction Line Temperature (heat pump).	
D2 Condenser Suction Temp (Heat Pump)	330 (330:0)	D2CondST	AI: 390	Current Compressor D2 Suction Line Temperature (heat pump).	
Condenser D1 Superheat (Heat Pump)	331 (330:1)	D1CondSH	AI: 391	Current Compressor D1 Superheat Temperature (heat pump).	
Condenser D2 Superheat (Heat Pump)	332 (330:2)	D2CondSH	AI: 392	Current Compressor D2 Superheat Temperature (heat pump).	
Condenser D1 Expansion Valve Position	333 (330:3)	D1CondEV	AI: 393	Current position of Condenser D1 expansion valve.	
Condenser D2 Expansion Valve Position	334 (330:4)	D2CondEV	AI: 394	Current position of Condenser D2 expansion valve.	
A1-4 Emergency Shutdown (RSMD)	335 (330:5)	AEmShtDn	BI: 395	Emergency shutdown input on Module A.	
B1-4 Emergency Shutdown (RSMD)	336 (330:6)	BEmShtDn	BI: 396	Emergency shutdown input on Module B.	
C1-4 Emergency Shutdown (RSMD)	337 (330:7)	CEmShtDn	BI: 397	Emergency shutdown input on Module C.	

Objects labeled AI and BI are read-only. Objects labeled AV are read/write. Objects labeled AV are read/write. Sensor Inputs are read-only.

BACNET AND DATA ARRAY INFORMATION

VCCX2 Controller

BACNET PROPERTIES AND PT-LINK DATA ARRAY CROSS REFERENCE FOR VCCX2

Parameter	Data Array Block	Name	Object	Description	Limits	
D1-4 Emergency Shutdown (RSMD)	338 (330:8)	DEmShtDn	BI: 398	Emergency shutdown input on Module D.		
Supply Setpoint Override	339 (330:9)	SaStOv	AV: 276	This will override whatever setpoint the Supply Air Temperature is currently being controlled to.	0°F (-17.7°C) 0 = no override.	200°F (93.3°C)
Space Temperature Value	340 (340:0)	SpcTVal	AV: 277	If the controller is configured for this operation, the user can write a Space Sensor value.	0°F (17.7°C)	120°F (48.8°C)
Space Humidity Value	341 (340:1)	SpcRhVal	AV: 278	If the controller is configured for this operation, the user can write a Space Humidity Sensor value.	0	100
Relief Fan VFD	343 (340:3)	RelFanOv	AV: 280	Override to force the VFD to this percentage speed. Configuring "auto" will restore normal unit control of the VFD speed.	0%	100%
Relief Pressure Value	344 (340:4)	RelPrVal	AV: 281	If the controller is configured for this operation, the user can write building pressure sensor value.	-0.5	0.5
Carbon Dioxide Value	345 (340:5)	CO2Val	AV: 282	If the controller is configured for this operation, the user can write a CO ₂ Sensor value.	0	3000
Outdoor Air Temperature Value	346 (340:6)	OaTVal	AV: 283	If the controller is configured for this operation, the user can write an Outdoor Sensor value.	-40°F (-40°C)	150°F (65.5°C)
Outdoor Air Humidity Value	347 (340:7)	OaRhVal	AV: 284	If the controller is configured for this operation, the user can write an Outdoor Humidity Sensor value.	0	100
High Level Enthalpy (Reserved)	348 (340:8)	HiLvIEtp	AV: 321	Reserved.	10	50
Low Level Enthalpy (Reserved)	349 (340:9)	LoLvIEtp	AV: 347	Reserved.	10	50
Max Plenum Pressure Setpoint Reset Limit	350 (350:0)	MxPPrRst	AV: 323	Reserved.	0.1	0.2
Min Plenum Pressure Setpoint Reset Limit	351 (350:1)	MnPPrRst	AV: 326	Reserved.	0.1	0.2
Enthalpy Enable Setpoint	352 (350:2)	EtpEnSp	AV: 327	If configured for comparative enthalpy economizer control, the OA enthalpy must be below this setpoint by the enthalpy enable deadband before the OA/RA enthalpy comparison will be utilized to enable the economizer.	25 BTU/lb.	35 BTU/lb.
Enthalpy Enable Deadband	353 (350:3)	EtpEnDb	AV: 329	The OA enthalpy must be below the enthalpy enable setpoint by this amount, and the OA enthalpy must be below the RA enthalpy by this amount to utilize the economizer.	0.3 BTU/lb.	1.5 BTU/lb.
Maximum Static Setpoint Reset Limit	354 (350:4)	MxStaRst	AV: 330	As the most open VAV damper rises above 80%, the static setpoint will reset up to this maximum limit.	0.01 "WG	3 "WG
Minimum Static Setpoint Reset Limit	355 (350:5)	MnStaRst	AV: 331	As the most open VAV damper drops below 80%, the static setpoint will reset down to this minimum reset limit.	0.01 "WG	3 "WG

Objects labeled AI and BI are read-only. Objects labeled AV are read/write. Objects labeled AV are read/write. Sensor Inputs are read-only.

BACNET AND DATA ARRAY INFORMATION

VCCX2 Controller

BACNET PROPERTIES AND PT-LINK DATA ARRAY CROSS REFERENCE FOR VCCX2

Parameter	Data Array Block	Name	Object	Description	Limits	
Static Setpoint Reset Interval	356 (350:6)	StaRstlv	AV: 333	The reset Interval is how often the setpoint reset calculation occurs. This must be an infrequent event so the default is 15 minutes.	10 min	60 min
Cool-Down Target Temperature	357 (350:7)	CIDnTgTp	AV: 336	If morning cool-down is configured, then upon entering occupied mode, the Cool-Down Mode will be activated if the return air is above this temperature by one degree.	50°F (10°C)	90°F (32.2°C)
Warm-Up Override	358 (350:8)	WmUpOv	AV: 340	Commands the unit into Morning Warm-Up Mode.	1 = Command Warm-Up Mode	
Cool Down Override	359 (350:9)	CIDnOv	AV: 341	Commands the unit into Morning Cool-Down Mode.	1 = Command Cool-Down Mode	
Return Air High Limit Protection (for Voting Units or CV Units Only)	360 (360:0)	RAHiLmtP	AV: 342	If the Return Air Temperature goes above this limit, the unit will revert to return air control.	60	100
Return Air Low Limit Protection (for Voting Units or CV Units Only)	361 (360:1)	RALoLmtP	AV: 343	If the Return Air Temperature goes below this limit, the unit will revert to return air control.	45	70
EF/RA Fan POF	362 (360:2)	EFRAFPOF	BI: 346	Exhaust fan / return fan proof of flow alarm.		

Objects labeled AI and BI are read-only. Objects labeled AV are read/write. Objects labeled AV are read/write. Sensor Inputs are read-only.

VCCX2 Controller

VCCX2 BACnet Property Identifier

```
VccxControlModeBits ::= ENUMERATED {  
    Supply Air Cooling Only          (0),  
    Supply Air Tempering             (1),  
    Outdoor Temperature Control     (2),  
    Return Air Constant Volume Mode (3),  
    Space Temp Constant Volume Mode (4),  
    Space Temp w/ High OA Content   (5),  
    Single Zone VAV                  (6)  
}
```

```
VccxControlStatusBits ::= ENUMERATED {  
    Unoccupied          (0),  
    Occupied           (1),  
    Override Mode      (2),  
    Holiday Unoccupied (3),  
    Holiday Occupied  (4),  
    Forced Occupied    (5),  
    Forced Unoccupied (6),  
    Remote Contact Occupied (7),  
    Reserved           (8),  
    Reserved           (9),  
    Reserved           (10),  
    OA Damper Calibration (11)  
}
```

```
VccxHVACModeStatusBits ::= ENUMERATED {  
    Off                (0),  
    Vent Mode          (1),  
    Cooling Mode       (2),  
    Heating Mode       (3),  
    Vent RH Mode       (4),  
    Cooling RH Mode    (5),  
    Heating RH Mode    (6),  
    Warm Up Mode       (7),  
    Purge Mode         (8),  
    Defrost Mode       (9),  
    Cool Down Mode     (10)  
}
```

BACNET AND DATA ARRAY INFORMATION

VCB-X Controller

BACnet Properties and PT-Link Data Array Cross Reference

BACNET PROPERTIES AND PT-LINK DATA ARRAY CROSS REFERENCE FOR VCB-X CONTROLLER						
Parameter	Data Array Block	Name	Object	Description	Limits	
Application Software Version	000 (0:0)	AppVer	AI: 99	Current version of the software in the unit.		
Cooling Setpoint Mirror	001 (0:1)	ClSt	AI: 7	Occupied Cooling Mode Enable Setpoint.		
Heating Setpoint Mirror	002 (0:2)	HtSt	AI: 31	Occupied Heating Mode Enable Setpoint.		
Space Temperature	003 (0:3)	SpcTp	AI: 72	Current value of the Space Temperature Sensor.		
Supply Air Temperature	004 (0:4)	SaTp	AI: 83	Current value of the Supply Air Temperature Sensor.		
Outdoor Air Temperature	005 (0:5)	OaTp	AI: 54	Current value of the Outdoor Temperature Sensor.		
Unit Mode	006 (0:6)	UnitMode	AI: 123		See Unit Mode Bits on page 50.	
Control Status	007 (0:7)	CtrlSts	AI: 4	Current operational status.	See Control Status Bits on page 50.	
Cooling Enabled	008 (0:8)	ClEnbl	AI: 6	Status indicates mechanical cooling is enabled to operate.		
Heating Enabled	009 (0:9)	HtEnbl	AI: 30	Status indicates that mechanical heating is enabled to operate.		
Economizer Enabled	010 (10:0)	EcoEnbl	AI: 15	Status indicates the economizer is enabled.		
Fan Starting Delay	011 (10:1)	FanDly	AI: 25	Indicates the current fan status related to request to run, fan starting delay or POF failure.	0 = No request 1 = Fan running 2 = Fan start delay 3 = POF failure	
OnBoard Relay Status	012 (10:2)	OnRlys	AI: 44		See On Board Relays Bits on page 50.	
Economizer Position	013 (10:3)	EcoPos	AI: 16	Current position of the economizer damper.		
VFD Position	014 (10:4)	VfdBwPos	AI: 88	Current position of the VFD blower fan signal.		
Alarm Status	015 (10:5)	AlmSts	AI: 1	Indicates that there is an alarm.	0 = No alarms 1 = Alarm(s) present See Alarm Group Bits on page 50.	
Alarm Group 1	016 (10:6)	AlmGrp1	AI: 104		See Alarm Group Bits on page 50.	
Alarm Group 2	017 (10:7)	AlmGrp2	AI: 105		See Alarm Group Bits on page 50.	
Alarm Group 3	018 (10:8)	AlmGrp3	AI: 106		See Alarm Group Bits on page 50.	
Bad Supply Air Temperature Sensor	019 (10:9)	SaTpAlm	BI: 2	Indicates a failure of the Supply Air Temperature Sensor.		
Outdoor Air Temperature Sensor Lost	020 (20:0)	OaTpAlm	BI: 117	Indicates a failure of the Outdoor Air Temperature Sensor.		
Space Temperature Sensor Lost	021 (20:1)	SpcTpAlm	BI: 101	Indicates a failure of the Space Temperature Sensor.		

Objects labeled AI and BI are read-only. Objects labeled AV are read/write. Sensor Inputs are read-only.

BACNET AND DATA ARRAY INFORMATION

VCB-X Controller

BACNET PROPERTIES AND PT-LINK DATA ARRAY CROSS REFERENCE FOR VCB-X CONTROLLER						
Parameter	Data Array Block	Name	Object	Description	Limits	
Mechanical Cooling Alarm	022 (20:2)	MchClAlm	BI: 94	Compressor relays are enabled but the supply air temperature has not fallen 5°F within a user-adjustable time period. This does not apply for modulating cooling.		
Mechanical Heating Alarm	023 (20:3)	MchHtAlm	BI: 95	Heating Mode has been initiated but the supply air temperature has not risen 5°F within a user-adjustable time period. This does not apply for modulating heating.		
Proof of Flow Alarm	024 (20:4)	PofAlm	BI: 26	Indicates no proof of water flow.		
Dirty Filter Alarm	025 (20:5)	DrtFIAlm	BI: 96	Alarm indicates the filters are dirty.		
Smoke Alarm / Emergency Shutdown	026 (20:6)	SmokeAlm	BI: 119	Indicates the Smoke Sensor has been activated. This will shut down the unit.		
Low Supply Air Temperature Alarm	027 (20:7)	LoSaAlm	BI: 37	The supply air has fallen below the Low SAT Cutoff Setpoint and cooling stages will begin to deactivate. If the unit is in Economizer, Vent, or Heating Mode the supply fan will shut off.		
High Supply Air Temperature Alarm	028 (20:8)	HiSaAlm	BI: 33	The supply air has risen above the High SAT Cutoff Setpoint. Heating stages begin to deactivate and the fan continues to run.		
Control Temperature Cooling Failure	029 (20:9)	CtrlTpCF	BI: 108	Activated if the control temperature does not get within 5°F to the Occupied Cooling Setpoint in an hour in the Cooling Mode. This alarm is not used in 100% outdoor air units or supply air control.		
Control Temperature Heating Failure	030 (30:0)	CtrlTpHF	BI: 109	Activated if the control temperature does not get within 5°F to the Occupied Heating Setpoint in an hour in the Heating Mode. This alarm is not used in 100% outdoor air units or supply air control.		
Control Temperature	031 (30:1)	CtrlTp	AI: 9	Current value of the Control Temperature Sensor.		
Indoor Humidity	032 (30:2)	InRh	AI: 67	Current value of the Indoor Humidity Sensor.		
Indoor Humidity Setpoint Mirror	033 (30:3)	InRhStM	AI: 114	Mirror of the InRhSt "read only."		
Modulating Cooling Position	034 (30:4)	MdClPos	AI: 115	Current position of the modulating cooling signal (chilled water or digital compressor).		
Modulating Heating Position	035 (30:5)	MdHtPos	AI: 116	Current position of the modulating heating signal (hot water or SCR heat).		

Objects labeled AI and BI are read-only. Objects labeled AV are read/write. Sensor Inputs are read-only.

BACNET AND DATA ARRAY INFORMATION

VCB-X Controller

BACNET PROPERTIES AND PT-LINK DATA ARRAY CROSS REFERENCE FOR VCB-X CONTROLLER						
Parameter	Data Array Block	Name	Object	Description	Limits	
Occupied Cooling Setpoint	036 (30:6)	OcpClSt	AV: 42	If the control temperature rises one degree above this setpoint, the control will activate the cooling demand. If the control temperature is the Supply Air Sensor, then the cooling demand is always active.	1	110
Occupied Heating Setpoint	037 (30:7)	OcpHtSt	AV: 43	If the control temperature drops one degree below this setpoint, the control will activate the heating demand. If the control temperature is the Supply Air Sensor, then there is no heating demand.	1	110
Unoccupied Cooling Offset	038 (30:8)	UnClOst	AV: 124	In Unoccupied Mode, this offsets the Occupied Cooling Setpoint by this user adjustable amount. If no unoccupied cooling is desired, use the default setting of 30°F for this setpoint.	0	30
Unoccupied Heating Offset	039 (30:9)	UnHtOst	AV: 125	In Unoccupied Mode, this offsets the Occupied Heating Setpoint by this user adjustable amount. If no unoccupied heating is desired, use the default setting of 30°F for this setpoint.	0	30
Supply Air Cooling Setpoint	040 (40:0)	SaClSt	AV: 77	Supply Air Cooling Setpoint. If supply air reset is configured, this is the low SAT cooling reset value.	30	80
Supply Air Heating Setpoint	041 (40:1)	SaHtSt	AV: 78	Supply Air Heating Setpoint. If supply air reset is configured, this is the low SAT heating reset value.	40	240
Space Temperature Offset	042 (40:2)	SpcTpOst	AV: 71	If the Space Temperature Sensor is reading incorrectly, use this option to enter an offset to adjust the sensor's temperature.	-100	100
Supply Air Temperature Offset	043 (40:3)	SaTpOst	AV: 80	If the Supply Air Temperature Sensor is reading incorrectly, use this offset to adjust the sensor's temperature.	-100	100
Outdoor Air Temperature Offset	044 (40:4)	OaTpOst	AV: 53	If the Outdoor Temperature Sensor is reading incorrectly, use this to enter an offset to adjust the sensor's temperature.	-100	100
Schedule Force	045 (40:5)	SchdFrc	AV: 66	0 = Auto (uses controller's schedule); 1 = Forced occupied; 2 = Forced unoccupied	0	2
On Board Relay 1	046 (40:6)	OnRly1	BI: 127	Current status of VCB-X main board relay 1.		
On Board Relay 2	047 (40:7)	OnRly2	BI: 128	Current status of VCB-X main board relay 2.		
On Board Relay 3	048 (40:8)	OnRly3	BI: 129	Current status of VCB-X main board relay 3.		
On Board Relay 4	049 (40:9)	OnRly4	BI: 130	Current status of VCB-X main board relay 4.		
On Board Relay 5	050 (50:0)	OnRly5	BI: 131	Current status of VCB-X main board relay 5.		
On Board Relay 6	051 (50:1)	OnRly6	BI: 259	Current status of VCB-X main board relay 6.		

Objects labeled AI and BI are read-only. Objects labeled AV are read/write. Sensor Inputs are read-only.

BACNET AND DATA ARRAY INFORMATION

VCB-X Controller

BACNET PROPERTIES AND PT-LINK DATA ARRAY CROSS REFERENCE FOR VCB-X CONTROLLER						
Parameter	Data Array Block	Name	Object	Description	Limits	
Expansion Module Relay 1	052 (50:2)	MnExRly1	BI: 311	Current status of Relay 1 on the EM1 Expansion Module.		
Expansion Module Relay 2	053 (50:3)	MnExRly2	BI: 312	Current status of Relay 2 on the EM1 Expansion Module.		
Expansion Module Relay 3	054 (50:4)	MnExRly3	BI: 313	Current status of Relay 3 on the EM1 Expansion Module.		
Expansion Module Relay 4	055 (50:5)	MnExRly4	BI: 314	Current status of Relay 4 on the EM1 Expansion Module.		
Expansion Module Relay 5	056 (50:6)	MnExRly5	BI: 315	Current status of Relay 5 on the EM1 Expansion Module.		
12 Relay Expansion Module Relay 1	057 (50:7)	RIExRly1	BI: 299	Current status of Relay 1 on the 12 Relay Expansion Module.		
12 Relay Expansion Module Relay 2	058 (50:8)	RIExRly2	BI: 300	Current status of Relay 2 on the 12 Relay Expansion Module.		
12 Relay Expansion Module Relay 3	059 (50:9)	RIExRly3	BI: 301	Current status of Relay 3 on the 12 Relay Expansion Module.		
12 Relay Expansion Module Relay 4	060 (60:0)	RIExRly4	BI: 302	Current status of Relay 4 on the 12 Relay Expansion Module.		
12 Relay Expansion Module Relay 5	060 (60:1)	RIExRly5	BI: 303	Current status of Relay 5 on the 12 Relay Expansion Module.		
12 Relay Expansion Module Relay 6	062 (60:2)	RIExRly6	BI: 304	Current status of Relay 6 on the 12 Relay Expansion Module.		
12 Relay Expansion Module Relay 7	063 (60:3)	RIExRly7	BI: 305	Current status of Relay 7 on the 12 Relay Expansion Module.		
12 Relay Expansion Module Relay 8	064 (60:4)	RIExRly8	BI: 306	Current status of Relay 8 on the 12 Relay Expansion Module.		
12 Relay Expansion Module Relay 9	065 (60:5)	RIExRly9	BI: 307	Current status of Relay 9 on the 12 Relay Expansion Module.		
12 Relay Expansion Module Relay 10	066 (60:6)	RIExRly10	BI: 308	Current status of Relay 10 on the 12 Relay Expansion Module.		
12 Relay Expansion Module Relay 11	067 (60:7)	RIExRly11	BI: 309	Current status of Relay 11 on the 12 Relay Expansion Module.		
12 Relay Expansion Module Relay 12	068 (60:8)	RIExRly12	BI: 310	Current status of Relay 12 on the 12 Relay Expansion Module.		
Minimum Economizer Position	069 (60:9)	MinEcoSt	AV: 151	Minimum position of the economizer in the Occupied Mode.	0	100
Outdoor Air CFM	070 (70:0)	OaCFM	AI: 193	Current outdoor airflow measurement minimum desired		
Exhaust Fan CFM	071 (70:1)	EtCFM	AI:194	Current exhaust airflow measurement		
Supply Air CFM	072 (70:2)	SaCFM	AI:195	Current supply airflow measurement.		
Force HVAC Mode	073 (70:3)	FrcHvacM	AV: 262	Overrides normal controller operation in order to force the unit into this desired mode. Configuring for "auto" will restore normal unit control of the mode of operation.	0 = Auto 1 = Vent 2 = Cool 3 = Heat 4 = Vent dehumidification 5 = Cool dehumidification 6 = Heat dehumidification	
Objects labeled AI and BI are read-only. Objects labeled AV are read/write. Sensor Inputs are read-only.						

BACNET AND DATA ARRAY INFORMATION

VCB-X Controller

BACNET PROPERTIES AND PT-LINK DATA ARRAY CROSS REFERENCE FOR VCB-X CONTROLLER						
Parameter	Data Array Block	Name	Object	Description	Limits	
Remote VFD Position Setpoint	074 (70:4)	FrcFanSp	AV: 266	Override to force the VFD to this percentage speed. Configuring "auto" will restore normal unit control of the VFD speed.	0%	100%
					Auto=65535	
Force Economizer	075 (70:5)	FrcEcono	AV: 267	Overrides all other outdoor air damper position commands so as to maintain this fixed position. Configuring for "auto" will restore normal unit control of the outdoor air damper/economizer operation.	0%	100%
					Auto=65535	
Current Supply Air Temperature Setpoint	076 (70:6)	SaTpStM	AI: 82	Current SAT Cooling or Heating Setpoint if there is no reset source. Current calculated SAT setpoint with reset source.		
Return Air Temperature	077 (70:7)	RaTp	AI: 64	Current value of the Return Temperature Sensor.		
Outdoor Humidity	078 (70:8)	OaRh	AI: 52	Current value of the Outdoor Humidity Sensor.		
Static Pressure	079 (70:9)	StaticPr	AI: 270	Current static pressure.		
CO ₂	080 (80:0)	CO2	AI: 271	Current CO ₂ Level.		
Building Pressure	080 (80:1)	BuildPr	AI: 272	Current value of the Building Pressure Sensor.		
Exhaust Fan Speed	082 (80:2)	EtFnSpd	AI: 273	Current value of the VFD relief fan signal.		
Coil Temperature	083 (80:3)	CoilTp	AI: 181	Current coil temperature reading.		
Return Air CFM	084 (80:4)	RaCFM	AI: 275	Current return airflow measurement.		
Head Pressure	085 (80:5)	HeadPr	AI: 276	Current value of the head pressure reading.		
Reheat Valve Position	086 (80:6)	RtVlvPos	AI: 277	Current position of MHGRV modulating hot gas reheat valve.		
Leaving Water Temperature	087 (80:7)	LvWtrTp	AI: 278	Leaving water temperature value.		
Modulating Gas Valve Position	088 (80:8)	MdGsVpos	AI: 274	Current position of MODGAS modulating gas valve control.		
Head Pressure Setpoint	089 (80:9)	HeadPrSt	AI: 279	Current Head Pressure Setpoint.		
Condenser Control Signal	090 (90:0)	CdCtrSg1	AI: 280	Condenser fan signal 1 status.		
Hood On Outdoor Air Cooling Setpoint	091 (90:1)	OaCiSt	AV: 45	This is the Cooling Mode Enable Setpoint used only in Hood On Mode.	1	110
Hood On Outdoor Air Heating Setpoint	092 (90:2)	OaHtSt	AV: 46	This is the Heating Mode Enable Setpoint used only in Hood On Mode.	1	110
Morning Warm-Up Return Air Target Setpoint	093 (90:3)	WmupTg	AV: 281	If configured, upon entering the Occupied Mode, the warm-up demand will be activated if the return air temperature is one degree below this setpoint.	50	90

Objects labeled AI and BI are read-only. Objects labeled AV are read/write. Sensor Inputs are read-only.

BACNET AND DATA ARRAY INFORMATION

VCB-X Controller

BACNET PROPERTIES AND PT-LINK DATA ARRAY CROSS REFERENCE FOR VCB-X CONTROLLER						
Parameter	Data Array Block	Name	Object	Description	Limits	
Dewpoint Setpoint	094 (90:4)	RhDewpSt	AV: 282	On a MUA unit, if the outdoor dewpoint rises above this setpoint, the unit will activate dehumidification.	35	80
Economizer Enable Setpoint	095 (90:5)	EcoEnbSt	AV: 283	The economizer is enabled if the outdoor drybulb, dewpoint, or wetbulb temperature falls below this setpoint.	-30	80
Return Air Temperature Sensor Offset	096 (90:6)	RaTpOst	AV: 65	If the Return Temperature Sensor is reading incorrectly, use this to enter an offset to adjust the sensor's temperature.	-100	100
Coil Temperature Offset	097 (90:7)	CoTpOfst	AV: 284	If the Coil Temperature Sensor is reading incorrectly, use this offset to adjust the sensor's temperature.	-100	100
Low Ambient Relay Setpoint	098 (90:8)	LWAmbnt	AV: 285	Temperature at which the low ambient relay will activate in the Occupied or Unoccupied Mode.	-30	70
Preheat Relay Setpoint	099 (90:9)	PreHtAmb	AV: 286	If the supply fan is energized, this is the temperature at which the preheat relay will activate. Operates only in the Occupied Mode.	-30	70
CO ₂ Minimum Setpoint	100 (100:0)	CO2MinLv	AV: 287	This is the threshold CO ₂ level at which the Economizer Min Damper Position Setpoint will begin to be reset higher.	0	2000
CO ₂ Maximum Setpoint	101 (100:1)	CO2MaxLv	AV: 288	This is the CO ₂ level at which the economizer minimum damper position will be reset to the economizer maximum position in high CO ₂ . In between the minimum and maximum CO ₂ levels the economizer minimum damper position will be proportionally reset between the configured minimum damper position and the maximum position in high CO ₂ .	0	2000
Indoor Humidity Setpoint	102 (100:2)	InRhSt	AV: 289	If Coil Temp Reset is being used this is also the lowest Space RH value that corresponds to the Hi Coil Temp Setpoint.	0	100
Static Pressure Setpoint	103 (100:3)	StatPrSt	AV: 290	Current Static Pressure Setpoint.	0.1	3
Building Pressure Setpoint	104 (100:4)	RfPrSt	AV: 118	Current Building Pressure Setpoint.	-0.2	0.2
Outdoor Air CFM	105 (100:5)	OACfmMin	AV: 291	Minimum Outdoor Airflow CFM Setpoint.	0.10 k	200 k
High Indoor Humidity Reset Limit	106 (100:6)	HiInRh	AV: 292	During Coil Temp Reset, this is the highest space RH value that corresponds to the Low Coil Temp Setpoint.	0	100
Head Pressure Setpoint in Cooling Mode	107 (100:7)	CIHdPrSt	AV: 293	This is the Head Pressure Setpoint the unit will control to in the Cooling Mode.	240 PSI	420 PSI
Head Pressure Setpoint in Reheat Mode	108 (100:8)	HtHdPrSt	AV: 294	This is the Head Pressure Setpoint the unit will control to in the Dehumidification Reheat Mode.	240 PSI	420 PSI

Objects labeled AI and BI are read-only. Objects labeled AV are read/write. Sensor Inputs are read-only.

BACNET AND DATA ARRAY INFORMATION

VCB-X Controller

BACNET PROPERTIES AND PT-LINK DATA ARRAY CROSS REFERENCE FOR VCB-X CONTROLLER						
Parameter	Data Array Block	Name	Object	Description	Limits	
Low Coil Temperature Setpoint Limit	109 (100:9)	LoCITpSt	AV: 295	This is the lowest the coil temperature will be reset to during space humidity reset of the Coil Suction Temperature Setpoint. If no coil temperature reset is required, this value should be set the same as the High Coil Temperature Setpoint.	35	70
High Coil Temperature Setpoint Limit	110 (110:0)	HiCITpSt	AV: 296	This is the highest the coil temperature will be reset to during space humidity reset of the Coil Suction Temperature Setpoint. If no coil temperature reset is required, this value should be set the same as the Low Coil Temperature Setpoint.	35	70
Supply Air Cool High Reset	111 (110:1)	SaCIRt	AV: 324	If supply air reset is configured, this is the high SAT cooling reset value.	0	100
Supply Air Heat High Reset	112 (110:2)	SaHtRt	AV: 325	If supply air reset is configured, this is the high SAT heating reset value.	0	250
Cooling Low Reset Source	113 (110:3)	CLoRt	AV: 326	If doing supply air setpoint reset, this is the low reset source value in cooling that will correspond to the Supply Air Cool High Reset Setpoint.	1	150
Cooling High Reset Source	114 (110:4)	CIHiRt	AV: 327	If doing supply air setpoint reset, this is the high reset source value in cooling that will correspond to the Supply Air Cooling Setpoint (Low Reset).	1	150
SAT Heating Low Reset Source	115 (110:5)	HtLoRt	AV: 328	If doing supply air setpoint reset, this is the low reset source value in heating that will correspond to the Supply Air Heating High Reset Setpoint.	1	150
SAT Heating High Reset Source	116 (110:6)	HtHiRt	AV: 329	If doing supply air setpoint reset, this is the high reset source value in cooling that will correspond to the Supply Air Cooling Setpoint (Low Reset).	1	150
Control Mode	117 (110:7)	CtrlMod	AI: 97		1 = Constant volume 2 = Supply air cooling only 3 = Outdoor temp control 4 = Single zone VAV 5 = Supply air tempering 6 = Space temp control w/high OA content unoccupied	
Compressor Discharge Temperature	118 (110:8)	DschgTp	AI: 331	Current value of the Compressor Discharge Temperature Sensor.		
Outdoor Wetbulb	119 (110:9)	OaWtbl	AI: 55	Current calculated value of the outdoor wetbulb temperature.		
Outdoor Air Dewpoint	120 (120:0)	OaDewPt	AI: 332	Current calculated outdoor air dew point.		
Current Slide Adjust Offset	120 (126:6)	SldAdOfs	AI: 338	Current slide adjust offset value.		
Suction Pressure	121 (120:1)	SucPr	AI: 333	Current suction pressure value.		

Objects labeled AI and BI are read-only. Objects labeled AV are read/write. Sensor Inputs are read-only.

BACNET AND DATA ARRAY INFORMATION

VCB-X Controller

BACNET PROPERTIES AND PT-LINK DATA ARRAY CROSS REFERENCE FOR VCB-X CONTROLLER						
Parameter	Data Array Block	Name	Object	Description	Limits	
Coil Temperature Setpoint	122 (120:2)	CoilTpSt	AI: 334	This is the current calculated coil suction temperature target during Dehumidification Mode.		
Return Bypass Damper Position	123 (120:3)	RetByDmp	AI: 335	Current return bypass damper position.		
Return Air Damper Position	124 (120:4)	RaDmp	AI: 336	Current return air damper position.		
Return Air Humidity	125 (120:5)	RaRH	AI: 337	Current value of the Return Air Humidity Sensor.		
Mode Select Deadband	127 (120:7)	MdSelDb	AV: 339	This setpoint is added to and subtracted from the HVAC mode setpoints to determine when the unit enters and leaves a mode of operation.	1	10
Cool Staging Window	128 (120:8)	ClStgWdw	AV: 340	In Cooling Mode, if the supply air temperature drops below the Active Supply Air Cooling Setpoint minus this staging window, a cooling stage will be deactivated after its minimum run time.	1	30
Heat Staging Window	129 (120:9)	HtStgWdw	AV: 341	In the Heating Mode, if the supply air temperature rises above the Active Supply Air Heating Setpoint plus the heating stage off window value, a heating stage will be deactivated after its minimum run time.	1	50
Mechanical Cooling Lockout	130 (130:0)	MchCILkt	AV: 342	The VCB-X will lockout mechanical cooling when the outdoor air temperature is below this setpoint.	-30	100
Mechanical Heating Lockout	131 (130:1)	MchHtLkt	AV: 343	The VCB-X will lockout mechanical heating when the outdoor air temperature is above this setpoint.	-30	150
Low Supply Air Temp Cutoff	132 (130:2)	LoSaCf	AV: 344	Cooling will be disabled if the supply air temperature falls below this value. See sequence for more details.	0	100
High Supply Air Temp Cutoff	133 (130:3)	HiSaCf	AV: 345	Heating will be disabled if the supply air temperature rises above this value. See sequence for more details.	0	250
Heat Wheel Defrost Setpoint	134 (130:4)	Dfrst	AV: 346	The unit will go into Heat Wheel Defrost Mode when the outdoor air is below this setpoint.	0	50
Leaving H ₂ O Offset	135 (130:5)	LvH2OOst	AV: 347	If the Leaving Water Temperature Sensor is reading incorrectly, use this to enter an offset to adjust the sensor's temperature.	-100	100
CO ₂ Sensor Calibration Deadband Offset	136 (130:6)	CO2Ost	AV: 348	If the CO ₂ Sensor is reading incorrectly, you can use this option to enter an offset value to adjust the sensor's CO ₂ reading.	-500 ppm	500 ppm
Controlling Sensor High Alarm Offset	137 (130:7)	CTpHiAlm	AV: 349	If the temperature of the controlling sensor rises above the Occupied Cooling Setpoint by this value, a high control temp alarm will occur. Only applies if configured for space or return air temp control, or as single zone VAV.	0	50

Objects labeled AI and BI are read-only. Objects labeled AV are read/write. Sensor Inputs are read-only.

BACNET AND DATA ARRAY INFORMATION

VCB-X Controller

BACNET PROPERTIES AND PT-LINK DATA ARRAY CROSS REFERENCE FOR VCB-X CONTROLLER						
Parameter	Data Array Block	Name	Object	Description	Limits	
Controlling Sensor Low Alarm Offset	138 (130:8)	CTpLoAlm	AV: 350	If the temperature of the controlling sensor falls below the Occupied Heating Setpoint by this value, a low control temp alarm will occur. Only applies if configured for Space or return air temp control, or as single zone VAV.	0	50
Heat Pump Compressor Heating Outdoor Lockout	139 (130:9)	HpLkt	AV: 351	Compressor heating will be locked out when the outdoor air temperature is below this setpoint.	-30	100
VFD Min Position in Cool Mode	140 (140:0)	VFDCiMin	AV: 319	In single zone VAV configuration, this is the fan speed at which the VFD will start when cooling is initiated. In a VAV configuration this is the lowest fan speed allowed in the Cooling Mode. In CAV and MUA configurations this should be set to 100%.	0%	100%
VFD Min Position in Heat Mode	141 (140:1)	VFDHtMin	AV: 320	In single zone VAV configuration, this is the fan speed at which the VFD will start when heating is initiated. In a VAV configuration this is the lowest fan speed allowed in the Heating Mode. In CAV and MUA configurations this should be set to 100%.	0%	100%
VFD Min Position in Vent Mode	142 (140:2)	VFDVtMin	AV: 322	Speed at which the VFD will operate in the Vent Mode in single zone VAV.	0%	100%
Max Economizer in Heat Mode	143 (140:3)	MaxEcoHt	AV: 353	Max position the economizer damper can open in the Heating Mode. Takes priority over max position in High CO ₂ .	0%	60%
Max Economizer in High CO ₂ Mode	144 (140:4)	MaxEcoCO	AV: 354	The maximum value the economizer minimum position can be reset up to during CO ₂ override.	0%	100%
Heat Pump Defrost Interval	145 (140:5)	HpDfrInt	AV: 355	The heat pump defrost interval is the length of time that must be met between Defrost Modes.	10 Min	120 Min
Adaptive Defrost Interval Adjustment	146 (140:6)	AptDfr	AV: 356	Adjustment to the heat pump defrost interval depending on whether the Defrost Mode lasts 10 minutes or less than 10 minutes.	0 Min	30 Min
Minimum Outdoor Air CFM Deadband	149 (140:9)	OacfmDb	AV: 359	The deadband is used both above and below the outdoor air CFM setpoint to help prevent hunting.	10	1000
SZ VAV Integral Constant	150 (150:0)	SZVAVFnI	AV: 360	This is the integral constant for controlling the SZ VAV fan speed.	0	10
Warmup Mode Supply Air Setpoint	151 (150:1)	SaWmupSt	AV: 361	Heating will be controlled to this Supply Air Setpoint during morning warm-Up.	40	240
Cooldown Mode Supply Air Setpoint	152 (150:2)	SaCldnSt	AV: 362	Cooling will be controlled to this Supply Air Setpoint during cool-down.	30	80
Reheat Enabled	153 (150:3)	RehtEnbl	BI: 363	Modulating hotgas reheat enabled.		
Emergency Heat Enabled	154 (150:4)	EmHtEnbl	BI: 364	Shows the emergency heat is enabled based on the compressor heating lockout.		

Objects labeled AI and BI are read-only. Objects labeled AV are read/write. Sensor Inputs are read-only.

BACNET AND DATA ARRAY INFORMATION

VCB-X Controller

BACNET PROPERTIES AND PT-LINK DATA ARRAY CROSS REFERENCE FOR VCB-X CONTROLLER						
Parameter	Data Array Block	Name	Object	Description	Limits	
Bad Return Air Sensor	155 (150:5)	RaTpAlm	BI: 365	Indicates a failure of the Return Air Sensor.		
Missing EM1 Expansion Module	156 (150:6)	MisEM1	BI: 366	Indicates that the EM1 Expansion Module is not communicating with the VCB-X Controller.		
Bad CO ₂ Sensor	158 (150:8)	CO2Alm	BI: 368	Failure of the CO ₂ Sensor.		
Bad Compressor Discharge Sensor	159 (150:9)	DschgAlm	BI: 369	Failure of the Digital Compressor Discharge Temperature Sensor.		
Missing Outdoor Air CFM Sensor	160 (160:0)	OaCfmAlm	BI: 370	Indicates Outdoor Air CFM Sensor is not detected.		
Missing Supply Air CFM Sensor	162 (160:2)	SaCfmSr	BI: 372	Indicates the Supply Air CFM Sensor is not detected.		
Missing Return Air CFM Sensor	163 (160:3)	RaCfmSr	BI: 373	Indicates that the Return Air CFM Sensor is not detected.		
Missing Reheat Module	164 (160:4)	MisMHGRV	BI: 374	Indicates that the MHGRV Module is not communicating with the VCB-X Controller.		
Missing MODGAS Module	165 (160:5)	MisMDGAS	BI: 375	Alarm indicates the MODGAS module is not communicating with the VCB-X Controller.		
Bad or Missing 12 Relay Expansion Board.	166 (160:6)	Mis12Rly	BI: 376	The 12 Relay Expansion Board is configured but not detected.		
High Control Mode Temperature	167 (160:7)	HiCtrlMd	BI: 377	Occurs when the controlling sensor temperature rises above the Cooling Mode Enable Setpoint plus the control mode high alarm offset. Applies only to space or return air temperature controlled units.		
Low Control Mode Temperature	168 (160:8)	LoCtrlMd	BI: 378	Occurs when the controlling sensor temperature falls below the Heating Mode Enable Setpoint minus the control mode low alarm offset. Applies only to space or return air temperature controlled units.		
Digital Compressor Cutoff	169 (160:9)	DigCmpCf	BI: 379	Occurs if the digital compressor discharge temperature rises above 268°F or the sensor is shorted. The compressor is disabled.		
Digital Compressor Lockout	170 (170:0)	DigCmpLk	BI: 380	Occurs if five digital compressor cutoffs occur within four hours. The compressor will be locked out.		
High Head Pressure	171 (170:1)	HiHedPr	BI: 381	Indicates the head pressure is too high.		
Water Proof of Flow Failure	172 (170:2)	H2OProf	BI: 382	Indicates no proof of water flow.		
Low Suction Pressure Alarm	173 (170:3)	LoSucPr	BI: 383	Indicates suction pressure is below the Low Suction Pressure Cooling (Heating) Setpoint.		
High Suction Pressure Alarm	174 (170:4)	HiSucPr	BI: 352	Indicates suction pressure is above the High Suction Pressure Cooling (Heating) Setpoint.		

Objects labeled AI and BI are read-only. Objects labeled AV are read/write. Sensor Inputs are read-only.

VCB-X Controller

VCB-X BACnet Property Identifier

The PT-Link II BACnet Link amends the following property identity to the BACnet property identifier.

VcbxUnitMode ::= ENUMERATED {

Unoccupied (0)
Occupied (1),
Override Mode (2),
Holiday Unoccupied (3),
Holiday Occupied (4),
Forced Occupied (5),
Forced Unoccupied (6),
}

VcbxControlStatusBits ::= ENUMERATED {

Off (0),
Vent Mode (1),
Cooling Mode (2),
Heating Mode (3),
Vent RH Mode (4),
Cooling RH Mode (5),
Heating RH Mode (6),
Warm Up Mode (7),
Defrost Mode (8),
Purge Mode (9),
Cool Down Mode (10),
Remote Cooling Mode (11),
Remote Heating Mode (12),
Remote Vent Dehum (13),
Remote Cool Dehum (14),
Remote Heat Dehum (15),
}

VcbxAlarmGroup1Bits ::= BIT STRING {

Bad Supply Air Sensor (0),
Bad Return Air Sensor (1),
Bad Outdoor Air Sensor (2),
Bad Space Sensor (3),
Bad Main Expansion Board (4),
Bad Coil Temp Sensor (5),
Bad Co2 Sensor (6),
Bad Discharge Sensor (7),
Bad OA CFM Sensor (8),
Bad Exhaust CFM Sensor (9),
Bad Supply CFM Sensor (10),
Bad Return CFM Sensor (11),
Bad Reheat Module (12),
Bad ModGas Module (13),
Bad Relay Expansion Module (14),
Missing EM2 Expansion Board (15),
}

VcbxAlarmGroup2Bits ::= BIT STRING {

Mechanical Cooling Failure (0),
Mechanical Heating Failure (1),
Fan Proving Alarm (2),
Dirty Filter Alarm (3),
Emergency Shutdown Alarm (4),
Economizer Air Temperature Failure (5),
Not Economizing When It Should (6),
Economizing When It Should Not (7),
Economizer Damper Failure (8),
Economizer Excess Outdoor Air (9),
}

VcbxAlarmGroup3Bits ::= BIT STRING {

High Supply Air Cutoff (0),
Low Supply Air Cutoff (1),
High Control Mode Signal Alarm (2),
Low Control Mode Signal Alarm (3),
Digital Compressor Cutoff Alarm (4),
Digital Compressor Lockout Alarm (5),
High Head Pressure (6),
Loop Water Proof of Flow (7),
Low Suction Pressure (8),
Unsafe Suction Pressure (9),
Low Leaving Water Temp (10),
}

VcbxOnBoardRelaysBits ::= BIT STRING {

On Board Relay 1 (0),
On Board Relay 2 (1),
On Board Relay 3 (2),
On Board Relay 4 (3),
On Board Relay 5 (4),
On Board Relay 6 (5),
}

BACNET AND DATA ARRAY INFORMATION

VCM-X Modular Controller

BACnet Properties and PT-Link Data Array Cross Reference

The following points for the VCM-X Modular, VCM-X and WSHP Controllers are additional points. All points and property identifiers in the VCM-X Controller table also apply to the VCM-X Modular, and VCM-X WSHP Controllers.

BACNET PROPERTIES AND PT-LINK DATA ARRAY CROSS REFERENCE FOR VCM-X MODULAR						
Parameter	Data Array Block	Name	Object	Description	Limits	
Modulating Compressor 2	106 (100:6)	MdCmp2	AI: 206	Current position of the second stage of compressor modulation.		
Head Pressure Signal 1 on Head Pressure Module 1	107 (100:7)	HdPr1	AI: 207	Head Pressure Signal 1 on Head Pressure Module 1.		
Head Pressure Signal 2 on Head Pressure Module 1	108 (100:8)	HdPr2	AI: 208	Head Pressure Signal 2 on Head Pressure Module 1.		
Condenser Fan Signal 1 on Head Pressure Module 1	109 (100:9)	CdFan1	AI: 209	Condenser Fan Signal 1 on Head Pressure Module 1.		
Condenser Fan Signal 2 on Head Pressure Module 1	110 (110:0)	CdFan2	AI: 210	Condenser Fan Signal 2 on Head Pressure Module 1.		
Remote VFD Reset	111 (110:1)	RmVFDPos	AV: 258	Remote VFD.	-1	100
Title 24 Economizer Feedback	118 (110:8)	T24EcFb	AI: 384	Current position of feedback from economizer actuator.		
Title 24 Sensor Alarm	119 (110:9)	T24TpAlm	BI: 385	Outdoor Air or Supply Air Temperature Sensor is shorted or missing.		
Title 24 Not Economizing When It Should	120 (120:0)	T24NEWS	BI: 386	Economizer is enabled but not following the desired economizer position commanded.		
Title 24 Economizing When It Should Not	121 (120:1)	T24EWISN	BI: 387	Economizer is not enabled but the feedback signal indicates a position more open than the minimum.		
Title 24 Damper Failure	122 (120:2)	T24DpAlm	BI: 388	Economizer is enabled but not within 10% of desired position within 150 seconds.		
Title 24 Excess Outdoor Air	123 (120:3)	T24ExsOA	BI: 389	Economizer feedback is lost or Economizer is not following commanded position.		
Position Reset Bad Return Air Sensor	124 (120:4)	RaTpAlm	BI: 365	Alarm that indicates a failure in the Return Air Sensor.		
Title 24 Economizer Alarms	125 (120:5)	AlmGrp5	AI: 391	Alarms for the 24 Title Economizer.		
Head Pressure Signal 1 on Head Pressure Module 2	126 (120:6)	HdPr21	AI: 394	Head Pressure Signal 1 on Head Pressure Module 2.		
Head Pressure Signal 2 on Head Pressure Module 2	127 (120:7)	HdPr22	AI: 395	Head Pressure Signal 2 on Head Pressure Module 2.		
Condenser Fan Signal 1 on Head Pressure Module 2	128 (120:8)	CdFan21	AI: 392	Condenser Fan Signal 1 on Head Pressure Module 2.		
Condenser Fan Signal 2 on Head Pressure Module 2	129 (120:9)	CdFan22	AI: 393	Condenser Fan Signal 2 on Head Pressure Module 2.		

Objects labeled AI and BI are read-only. Objects labeled AV are read/write. Sensor Inputs are read-only.

BACNET AND DATA ARRAY INFORMATION

VCM-X WSHP (Tulsa) Controller

BACnet Properties and PT-Link Data Array Cross Reference

BACNET PROPERTIES AND PT-LINK DATA ARRAY CROSS REFERENCE FOR VCM-X WSHP (TULSA)						
Parameter	Data Array Block	Name	Object	Description	Limits	
Modulating Compressor 2	106 (100:6)	MdCmp2	AI: 206	Current position of the second stage of compressor modulation.		
Head Pressure Signal 1 on Head Pressure Module 1	107 (100:7)	HdPr1	AI: 207	Head Pressure Signal 1 on Head Pressure Module 1.		
Head Pressure Signal 2 on Head Pressure Module 1	108 (100:8)	HdPr2	AI: 208	Head Pressure Signal 2 on Head Pressure Module 1.		
Condenser Fan Signal 1 on Head Pressure Module 1	109 (100:9)	CdFan1	AI: 209	Condenser Fan Signal 1 on Head Pressure Module 1.		
Condenser Fan Signal 2 on Head Pressure Module 1	110 (110:0)	CdFan2	AI: 210	Condenser Fan Signal 2 on Head Pressure Module 1.		
Water Temp. A	111 (110:1)	WaterTpA	AI: 220	Current water temperature of refrigerant for System A.		
Water Temp. B	112 (110:2)	WaterTpB	AI: 221	Current water temperature of refrigerant for System B.		
Compressor A1 Low Suction Pressure Alarm	113 (110:3)	A1LSPAlm	BI: 222	Alarm indicates suction pressure for Compressor A1 is below the Low Suction Pressure Cooling (Heating) Setpoint.		
Compressor A1 Lockout Alarm	114 (110:4)	A1LktAlm	BI: 223	Alarm indicates Compressor A1 is locked out.		
Compressor A2 Low Suction Pressure Alarm	115 (110:5)	A2LSPAlm	BI: 224	Alarm indicates suction pressure for Compressor A2 is below the Low Suction Pressure Cooling (Heating) Setpoint.		
Compressor A2 Lockout Alarm	116 (110:6)	A2LktAlm	BI: 225	Alarm indicates Compressor A2 is locked out.		
Compressor B1 Low Suction Pressure Alarm	117 (110:7)	B1LSPAlm	BI: 226	Alarm indicates suction pressure for Compressor B1 is below the Low Suction Pressure Cooling (Heating) Setpoint.		
Compressor B1 Lockout Alarm	118 (110:8)	B1LktAlm	BI: 227	Alarm indicates Compressor B1 is locked out.		
Compressor B2 Low Suction Pressure Alarm	119 (110:9)	B2LSPAlm	BI: 228	Alarm indicates suction pressure for Compressor B2 is below the Low Suction Pressure Cooling (Heating) Setpoint.		
Compressor 4 Lockout Alarm	120 (120:0)	B2LktAlm	BI: 229	Alarm indicates Compressor B2 is locked out.		
Low Water Temperature 1 Alarm	121 (120:1)	LWT1Alm	BI: 230	Alarm indicates water temperature is below the Leaving Water Safety Setpoint (heating only) for System A.		
Low Water Temperature 2 Alarm	122 (120:2)	LWT2Alm	BI: 231	Alarm indicates water temperature is below the Leaving Water Safety Setpoint (heating only) for System B.		
Proof of Water 1 Flow Alarm	123 (120:3)	POWF1Alm	BI: 232	Alarm indicates no proof of water flow for System A (A1/A2).		
Proof of Water 2 Flow Alarm	124 (120:4)	POWF2Alm	BI: 233	Alarm that indicates no proof of water Flow for System B (B1/B2).		

Objects labeled AI and BI are read-only. Objects labeled AV are read/write. Sensor Inputs are read-only.

BACNET AND DATA ARRAY INFORMATION

VCM-X WSHP (Tulsa) Controller

BACNET PROPERTIES AND PT-LINK DATA ARRAY CROSS REFERENCE FOR VCM-X WSHP (TULSA)

Parameter	Data Array Block	Name	Object	Description	Limits	
Module Communications Alarm	125 (120:5)	ComMAIm	BI: 234	Alarm indicates one or more modules are not communicating with the VCM-X WSHP Controller.		
Remote VFD Reset	126 (120:6)	RmVFDPoS	AV: 258	Remote VFD position reset.	-1	100
Title 24 Economizer Feedback	133 (130:3)	T24EcFb	AI: 384	Current position of feedback from economizer actuator.		
Title 24 Sensor Alarm	134 (130:4)	T24TpAlm	BI: 385	Outdoor Air or Supply Air Temperature Sensor is shorted or missing.		
Title 24 Not Economizing When It Should	135 (130:5)	T24NEWS	BI: 386	Economizer is enabled but not following the desired economizer position commanded.		
Title 24 Economizing When It Should Not	136 (130:6)	T24EWISN	BI: 387	Economizer is not enabled but the feedback signal indicates a position more open than the minimum.		
Title 24 Damper Failure	137 (130:7)	T24DpAlm	BI: 388	Economizer is enabled but not within 10% of desired position within 150 seconds.		
Title 24 Excess Outdoor Air	138 (130:8)	T24ExsOA	BI: 389	Economizer feedback is lost or economizer is not following commanded position.		
Bad Return Air Sensor	139 (130:9)	RaTpAlm	BI: 365	Alarm indicates a failure in the Return Air Sensor.		
Title 24 Economizer Alarms	140 (140:0)	AlmGrp5	AI: 391	Alarms for the 24 Title Economizer.		
Head Pressure Signal 1 on Head Pressure Module 2	142 (140:2)	HdPr21	AI: 394	Head Pressure Signal 1 on Head Pressure Module 2.		
Head Pressure Signal 2 on Head Pressure Module 2	143 (140:3)	HdPr22	AI: 395	Head Pressure Signal 2 on Head Pressure Module 2.		
Condenser Fan Signal 1 on Head Pressure Module 2	143 (140:3)	CdFan21	AI: 392	Condenser Fan Signal 1 on Head Pressure Module 2.		
Condenser Fan Signal 2 on Head Pressure Module 2	144 (140:4)	CdFan22	AI: 393	Condenser Fan Signal 2 on Head Pressure Module 2.		

Objects labeled AI and BI are read-only. Objects labeled AV are read/write. Sensor Inputs are read-only.

BACNET AND DATA ARRAY INFORMATION

VCM-X WSHP (Coil) Controller

BACnet Properties and PT-Link Data Array Cross Reference

BACNET PROPERTIES AND PT-LINK DATA ARRAY CROSS REFERENCE FOR VCM-X WSHP (COIL)						
Parameter	Data Array Block	Name	Object	Description	Limits	
Modulating Compressor 2	106 (100:6)	MdCmp2	AI: 206	Current position of the second stage of compressor modulation.		
Head Pressure 1	107 (100:7)	HdPr1	AI: 207	Head Pressure for Compressor 1.		
Head Pressure 2	108 (100:8)	HdPr2	AI: 208	Head Pressure for Compressor 2.		
Condenser Fan 1	109 (100:9)	CdFan1	AI: 209	Condenser Fan 1 Signal Status.		
Condenser Fan 2	110 (110:0)	CdFan2	AI: 210	Condenser Fan 2 Signal Status.		
Water Temp. A	111 (110:1)	WaterTpA	AI: 220	Current water temperature.		
Compressor A Low Suction Pressure Alarm	112 (110:2)	A1LSPAlm	BI: 222	Alarm that indicates suction pressure for Circuit A is below the Low Suction Pressure Cooling (Heating) Setpoint.		
Compressor A Lockout Alarm	113 (110:3)	A1LktAlm	BI: 223	Alarm that indicates Circuit A Compressors are locked out.		
Compressor B Low Suction Pressure Alarm	114 (110:4)	B1LSPAlm	BI: 226	Alarm that indicates suction pressure for Circuit B is below the Low Suction Pressure Cooling (Heating) Setpoint.		
Compressor B Lockout Alarm	115 (110:5)	B1LktAlm	BI: 227	Alarm that indicates Circuit B Compressors are locked out.		
Low Water Temperature Alarm	116 (110:6)	LWT1Alm	BI: 230	Alarm that indicates water temperature is below the Leaving Water Safety Setpoint (heating only).		
Proof of Water Flow Alarm	117 (110:7)	POWF1Alm	BI: 232	Alarm that indicates no proof of water flow.		
Module Communications Alarm	118 (110:8)	ComMAIm	BI: 234	Alarm that indicates that one or more modules are not communicating with the VCM-X WSHP Controller.		
Remote VFD Reset	119 (110:9)	RmVFDPoS	AV: 258	Remote VFD Position Reset.	-1	100
Title 24 Economizer Feedback	126 (120:6)	T24EcFb	AI: 384	Current position of feedback from economizer actuator.		
Title 24 Sensor Alarm	127 (120:7)	T24TpAlm	BI: 385	Outdoor Air or Supply Air Temperature Sensor is shorted or missing.		
Title 24 Not Economizing When It Should	128 (120:8)	T24NEWS	BI: 386	Economizer is enabled but not following the desired economizer position commanded.		
Title 24 Economizing When It Should Not	129 (120:9)	T24EWISN	BI: 387	Economizer is not enabled but the feedback signal indicates a position more open than the minimum.		
Title 24 Damper Failure	130 (130:0)	T24DpAlm	BI: 388	Economizer is enabled but not within 10% of desired position within 150 seconds.		
Title 24 Excess Outdoor Air	131 (130:1)	T24ExsOA	BI: 389	Economizer feedback is lost or economizer is not following commanded position.		
Bad Return Air Sensor	132 (130:2)	RaTpAlm	BI: 365	Alarm that indicates a failure in the Return Air Sensor.		

Objects labeled AI and BI are read-only. Objects labeled AV are read/write. Sensor Inputs are read-only.

BACNET AND DATA ARRAY INFORMATION

VCM-X Controller

BACnet Properties and PT-Link Data Array Cross Reference

BACNET PROPERTIES AND PT-LINK DATA ARRAY CROSS REFERENCE FOR VCM-X						
Parameter	Data Array Block	Name	Object	Description	Limits	
Application Software Version	000 (0:0)	AppVer	AI: 99	Current version of the software in the unit.		
Occupied Mode Enable Cooling Setpoint Mirror	001 (0:1)	ClSt	AI: 7	Occupied Mode Enable Cooling Setpoint Mirror.		
Occupied Mode Enable Heating Setpoint Mirror	002 (0:2)	HtSt	AI: 31	Occupied Mode Enable Heating Setpoint Mirror.		
Outdoor Air Wetbulb	003 (0:3)	OaWtbl	AI: 55	Current calculated value of the outdoor wetbulb temperature.		
Temperature Demand	004 (0:4)	TpDmnd	AI: 84	Based on the comparison between the current control temperature and the Heating or Cooling Setpoint temperatures. Does not work for supply air control.		
Space Temperature	005 (0:5)	SpcTp	AI: 72	Current value of the space temperature sensor.		
Supply Air Temperature	006 (0:6)	SaTp	AI: 83	Current value of the supply air temperature sensor.		
Return Air Temperature	007 (0:7)	RaTp	AI: 64	Current value of the return temperature sensor.		
Outdoor Air Temperature	008 (0:8)	OaTp	AI: 54	Current value of the outdoor temperature sensor.		
Duct Static Pressure	009 (0:9)	DuctPr	AI: 14	Current value of the duct static pressure sensor.		
Outdoor Air Humidity	010 (10:0)	OaRh	AI: 52	Current value of the outdoor humidity sensor.		
Unit Mode	011 (10:1)	UnitMode	AI: 123		See Unit Mode on page 61.	
Control Status	012 (10:2)	CtrlSts	AI: 4	Current operational status.		
Cooling Enabled	013 (10:3)	ClEnbl	BI: 6	Status that indicates mechanical cooling is enabled.		
Heating Enabled	014 (10:4)	HtEnbl	BI: 30	Status that indicates that mechanical heating is enabled.		
Economizer Enabled	015 (10:5)	EcoEnbl	BI: 15	Status that indicates the economizer is enabled.		
Fan Start Up Delay	016 (10:6)	FanDly	BI: 25	Status that indicates the fan is commanded to run, but it is in the start up delay mode.		
Proof of Flow Configured	017 (10:7)	PofCfg	BI: 57	Status that indicates the proof of flow function has been configured.		
CO2 Sensor Installed	018 (10:8)	CO2Cfg	BI: 3	Status that indicates the CO ₂ function has been configured.		
MODGAS II Connected	019 (10:9)	MdHt2Ins	BI: 39	Status that indicates the MODGAS II controller is connected.		

Objects labeled AI and BI are read-only. Objects labeled AV are read/write. Sensor Inputs are read-only.

BACNET AND DATA ARRAY INFORMATION

VCM-X Controller

BACNET PROPERTIES AND PT-LINK DATA ARRAY CROSS REFERENCE FOR VCM-X

Parameter	Data Array Block	Name	Object	Description	Limits
REHEAT II Connected	020 (20:0)	Rt2Ins	BI: 58	Status indicates the MHGRV controllers is connected to the system.	
On Board Relays	021 (20:1)	OnRlys	AI: 44		See On Board Relays Bits page 61.
External Relays 1-2	022 (20:2)	ExRlys12	AI: 111		See External Relays page 61.
External Relays 3-4	023 (20:3)	ExRlys34	AI: 112		See External Relays page 61
Economizer Position	024 (20:4)	EcoPos	AI: 16	Current position of the economizer damper.	
VFD Blower Fan	025 (20:5)	VfdBwPos	AI: 88	Current position of the VFD blower fan signal.	
VFD Relief Fan	026 (20:6)	VfdExPos	AI: 89	Current position of the VFD relief fan signal.	
Alarm Status	027 (20:7)	AlmSts	AI: 1		See Alarm Status on page 61.
Alarm Group 1	028 (20:8)	AlrmGrp1	AI: 104		See Alarm Group Bits on page 61.
Alarm Group 2	029 (20:9)	AlrmGrp2	AI: 105		See Alarm Group Bits on page 61.
Alarm Group 3	030 (30:0)	AlrmGrp3	AI: 106		See Alarm Group Bits on page 61.
Bad Supply Air Sensor	031 (30:1)	SaTpAlm	BI: 2	Alarm indicates a failure in the supply air sensor.	
Outdoor Air Temperature Lost	032 (30:2)	OaTpAlm	BI: 117	Alarm indicates a failure in the outdoor air temperature.	
Space Temperature Sensor Lost	033 (30:3)	SpcTpAlm	BI: 101	Alarm indicates a failure in the space temperature sensor.	
Mechanical Cooling Alarm	034 (30:4)	MchClAlm	BI: 94	Compressor relays are enabled but the supply air temperature has not fallen 5°F within a user-adjustable time period. This does not indicate compressors are active and will not shut the unit down.	
Mechanical Heating Alarm	035 (30:5)	MchHtAlm	BI: 95	Heating Mode has been initiated but the supply air temperature has not risen 5°F within a user-adjustable time period. This does not indicate heat stages are active and will not shut the unit down.	
Fan Proving Alarm	036 (30:6)	PofAlm	BI: 26	Alarm indicates a failure in the flow of the VFD blower.	
Dirty Filter Detected	037 (30:7)	DrtFIAlm	BI: 96	Alarm indicates the filters are dirty.	
Smoke Detector Alarm	038 (30:8)	SmokeAlm	BI: 119	Alarm indicates the Smoke Sensor has been activated.	
Low Supply Air Temperature Alarm	039 (30:9)	LoSaAlm	BI: 37	The supply air has fallen below the Hi SAT Cutoff Setpoint and cooling stages will begin to deactivate. If the unit is in Economizer, Vent, or Heating Mode the supply fan will shut off.	

Objects labeled AI and BI are read-only. Objects labeled AV are read/write. Sensor Inputs are read-only.

BACNET AND DATA ARRAY INFORMATION

VCM-X Controller

BACNET PROPERTIES AND PT-LINK DATA ARRAY CROSS REFERENCE FOR VCM-X						
Parameter	Data Array Block	Name	Object	Description	Limits	
High Supply Air Temperature Alarm	040 (40:0)	HiSaAlm	BI: 33	The Supply Air has risen above the Hi SAT Cutoff Setpoint. Heating stages begin to deactivate and the fan continues to run.		
Control Temperature Cool Failure	041 (40:1)	CtrlTpCF	BI: 108	This alarm is activated if the control temperature does not get within 5°F to the Occupied Cooling Setpoint in an hour in the Cooling Mode. This alarm is not used in 100% outdoor air units or supply air control.		
Control Temperature Heat Failure	042 (40:2)	CtrlTpHF	BI: 109	This alarm is activated if the control temperature does not get within 5°F to the Occupied Heating Setpoint in an hour in the Heating Mode. This alarm is not used in 100% outdoor air units or supply air control.		
Control Temperature	043 (40:3)	CtrlTp	AI: 9	Current value of the control temperature sensor.		
Indoor Humidity	044 (40:4)	InRh	AI: 67	Current value of the Indoor Humidity Sensor.		
Indoor Rh Setpoint Mirror	045 (40:5)	InRhStM	AI: 114	Mirror of the InRhSt "read only."		
Dewpoint Setpoint Mirror	046 (40:6)	DptStM	AI: 110	Mirror of the DPTSt "read only."		
Modulating Cool Position	047 (40:7)	MdClPos	AI: 115	Current position of the modulating cooling signal (chilled water or digital compressor).		
Modulating Heat Position	048 (40:8)	MdHtPos	AI: 116	Current position of the modulating heating signal (hot water or SCR heat).		
Modulating Gas Valve Position	049 (40:9)	MdHt2Pos	AI: 38	Current position of MODGAS II modulating gas valve control.		
Reheat Valve Position	050 (50:0)	Rt2Pos	AI: 60	Current position of MHGRV modulating hot gas reheat valve control.		
Occupied Mode Enable Cooling Setpoint	051 (50:1)	OcpClSt	AV: 42	If the control temperature rises one degree above this setpoint, the control will activate the cooling demand. If the control temperature is the Supply Air Sensor, then the cooling demand is always active.	0	99
Occupied Mode Enable Heating Setpoint	052 (50:2)	OcpHtSt	AV: 43	If the control temperature drops one degree below this setpoint, the control will activate the heating demand. If the control temperature is the Supply Air Sensor, then there is no heating demand.	0	99
Unoccupied Cooling Offset	053 (50:3)	UnClOst	AV: 124	During the Unoccupied Mode of operation, this setpoint spreads the Occupied Cooling Setpoint out by a user adjustable amount. If you do not want cooling to operate during the Unoccupied Mode, use the default setting of 30°F for these setpoints.	0	30

Objects labeled AI and BI are read-only. Objects labeled AV are read/write. Sensor Inputs are read-only.

BACNET AND DATA ARRAY INFORMATION

VCM-X Controller

BACNET PROPERTIES AND PT-LINK DATA ARRAY CROSS REFERENCE FOR VCM-X						
Parameter	Data Array Block	Name	Object	Description	Limits	
Unoccupied Heating Offset	054 (50:4)	UnHtOst	AV: 125	During the Unoccupied Mode of operation, this setpoint spreads the Occupied Heating Setpoint out by a user adjustable amount. If you do not want heating to operate during the Unoccupied Mode, use the default setting of 30°F for these setpoints.		
Wet Bulb Setpoint	055 (50:5)	WtblSt	AV: 92	The economizer is enabled if the outdoor temperature or wetbulb falls below this setpoint.	0	80
SAT Cooling Setpoint	056 (50:6)	SaClSt	AV: 77	Supply Air Setpoint in Cooling Mode.	40	80
Space Sensor Offset	056 (50:6)	SpcTpOst	AV: 71	If the Space Temperature Sensor is reading incorrectly, you can use this option to enter an offset temperature to adjust the sensor's temperature.	-100	100
SAT Heating Setpoint	057 (50:7)	SaHtSt	AV: 78	Supply Air Setpoint in Heating Mode.	40	200
Warm Up Setpoint	058 (50:8)	WmupSt	AV: 91	In a VAV application, upon entering the occupied mode, the warm-up demand will be activated if the return air temperature falls one degree below this setpoint.	50	90
Supply Air Sensor Offset	060 (60:0)	SaTpOst	AV: 80	If the Supply Air Temperature Sensor is reading incorrectly, you can use this option to enter an offset temperature to adjust the sensor's temperature.	-100	100
Return Air Sensor Offset	061 (60:1)	RaTpOst	AV: 65	If the Return Temperature Sensor is reading incorrectly, you can use this option to enter an offset temperature to adjust the sensor's temperature.	-100	100
Outdoor Air Sensor Offset	062 (60:2)	OaTpOst	AV: 53	If the Outdoor Temperature Sensor is reading incorrectly, you can use this option to enter an offset temperature to adjust the sensor's temperature.	-100	100
Coil Temperature Setpoint	063 (60:3)	CoilTpSt	AV: 107	This is the coil suction temperature target during dehumidification mode. Produces dewpoint in the supply air approximately 10°F above this setpoint.	35	70
Dewpoint Setpoint	064 (60:4)	DptSt	AV: 13	If the outdoor dewpoint rises above this setpoint, the unit will activate the dehumidification demand.	35	80
Indoor Humidity Setpoint	065 (60:5)	InRhSt	AV: 120	If the indoor humidity rises above this setpoint, the unit will activate the dehumidification demand.	0	100
Static Pressure Setpoint	066 (60:6)	DuctPrSt	AV: 152	This is the target duct pressure to be maintained by the VFD blower signal.	0.01	3
Relief Pressure Setpoint	067 (60:7)	RfPrSt	AV: 118	This is the target building pressure to be maintained by the VFD relief signal.	-0.2	0.2
Schedule Force	068 (60:8)	SchdFrc	AV: 66	0 = Auto/Unoccupied mode 1 = Forced on 2 = Forced off	0	2

Objects labeled AI and BI are read-only. Objects labeled AV are read/write. Sensor Inputs are read-only.

BACNET AND DATA ARRAY INFORMATION

VCM-X Controller

BACNET PROPERTIES AND PT-LINK DATA ARRAY CROSS REFERENCE FOR VCM-X						
Parameter	Data Array Block	Name	Object	Description	Limits	
On Board Relay 1	069 (60:9)	OnRly1	BI: 127	Current status of relay 1.		
On Board Relay 2	070 (70:0)	OnRly2	BI: 128	Current status of relay 2.		
On Board Relay 3	071 (70:1)	OnRly3	BI: 129	Current status of relay 3.		
On Board Relay 4	072 (70:2)	OnRly4	BI: 130	Current status of relay 4.		
On Board Relay 5	073 (70:3)	OnRly5	BI: 131	Current status of relay 5.		
Expansion Relay 1	074 (70:4)	ExRly1	BI: 133	Current status of relay 6.		
Expansion Relay 2	075 (70:5)	ExRly2	BI: 134	Current status of relay 7.		
Expansion Relay 3	076 (70:6)	ExRly3	BI: 135	Current status of relay 8.		
Expansion Relay 4	077 (70:7)	ExRly4	BI: 136	Current status of relay 9.		
Expansion Relay 5	078 (70:8)	ExRly5	BI: 137	Current status of relay 10.		
Expansion Relay 6	079 (70:9)	ExRly6	BI: 138	Current status of relay 11.		
Expansion Relay 7	080 (80:0)	ExRly7	BI: 139	Current status of relay 12.		
Expansion Relay 8	081 (80:1)	ExRly8	BI: 140	Current status of relay 13.		
Expansion Relay 9	082 (80:2)	ExRly9	BI: 141	Current status of relay 14.		
Expansion Relay 10	083 (80:3)	ExRly10	BI: 142	Current status of relay 15.		
Expansion Relay 11	084 (80:4)	ExRly11	BI: 143	Current status of relay 16.		
Expansion Relay 12	085 (80:5)	ExRly12	BI: 144	Current status of relay 17.		
Expansion Relay 13	086 (80:6)	ExRly13	BI: 145	Current status of relay 18.		
Expansion Relay 14	087 (80:7)	ExRly14	BI: 146	Current status of relay 19.		
Expansion Relay 15	088 (80:8)	ExRly15	BI: 147	Current status of relay 20.		
Expansion Relay 16	089 (80:9)	ExRly16	BI: 148	Current status of relay 21.		
CO ₂ Setpoint	090 (90:0)	CO2St	AV: 149	When the CO ₂ level rises above the CO ₂ protection limit max level, the economizer's minimum position will begin to reset open proportionally between the CO ₂ Protection Limit Max Level Setpoint and the Reset Range Setpoint.	0	3000

Objects labeled AI and BI are read-only. Objects labeled AV are read/write. Sensor Inputs are read-only.

BACNET AND DATA ARRAY INFORMATION

VCM-X Controller

BACNET PROPERTIES AND PT-LINK DATA ARRAY CROSS REFERENCE FOR VCM-X

Parameter	Data Array Block	Name	Object	Description	Limits	
Minimum Outdoor Air Setpoint	091 (90:1)	MinEcoSt	AV: 151	This is the minimum position of the economizer in the occupied modes.	1	100
Return Air CO ₂ Level	092 (90:2)	CO2Level	AI: 150	Current value of the CO ₂ sensor.		
Bypass Damper Position	093 (90:3)	ByPasDmp	AI: 153	Current position of the bypass damper signal.		
Return Damper Position	094 (90:4)	RaDmp	AI: 154	Current position of the return damper signal.		
Relief Pressure	095 (90:5)	RfPr	AI: 62	Current value of the building pressure sensor.		
Outdoor Air Dewpoint	096 (90:6)	OaDwpt	AI: 47	Current calculated outdoor air dewpoint added on version 1.09.		
Coil Temperature	097 (90:7)	CoilTp	AI: 181	Current coil temperature reading added on version 1.09.		
Current Supply Air Setpoint	098 (90:8)	SaTpStM	AI: 82	Current SAT. Cooling or Heating Setpoint if there is no reset source. Current calculated SAT Setpoint with reset source.		
Preheater Setpoint	099 (90:9)	PreHtSp	AV: 196	Low Outside Air Ambient Protection Setpoint	0	100
Outdoor Air CFM	100 (100:0)	OaCFM	AI: 193	Current outdoor airflow measurement		
Exhaust CFM	101 (100:1)	EtCFM	AI: 194	Current exhaust airflow measurement		
Supply Air CFM	102 (100:2)	SaCFM	AI: 195	Current supply airflow measurement		
Outdoor Air CFM Setpoint	103 (100:3)	OACfmSt	AV: 203	Minimum desired outdoor air CFM.	0.10 k	200 k
Outdoor Air CFM Reset Limit	104 (100:4)	OACfmRs	AV: 204	Maximum desired outdoor air CFM when CO ₂ reaches its reset limit.	0.10 k	200 k
Current Calculated OA CFM Setpoint	105 (100:5)	OACfmStM	AI: 205	Current calculated outdoor air CFM based on CO ₂ level.		
Supply Air Cool High Reset	106 (100:6)	SaClRt	AV: 324	High supply air cooling reset limit	40	150
Supply Air Heat High Reset	107 (100:7)	SaHtRt	AV: 325	High supply air heating reset limit	40	150
Cooling Low Reset Source	108 (100:8)	ClLoRt	AV: 326	Low Cool Reset Source Setpoint	1	150
Cooling High Reset Source	109 (100:9)	ClHiRt	AV: 327	High Cool Reset Source Setpoint	1	150
Heating Low Reset Source	110 (110:0)	HtLoRt	AV: 328	Low Heat Reset Source Setpoint	1	150
Heating High Reset Source	111 (110:1)	HtHiRt	AV: 329	High Heat Reset Source Setpoint	1	150

Objects labeled AI and BI are read-only. Objects labeled AV are read/write. Sensor Inputs are read-only.

VCM-X Controller

VCM-X BACnet Property Identifier

The PT-Link II BACnet Link amends the following property identity to the BACnet property identifier.

```

WattBACNETScheduleForce ::= ENUMERATED {
    NormalOperation          (0),
    ForceOccupied           (1),
    ForceUnoccupied         (2)
}
    
```

```

VcmxUnitMode ::= ENUMERATED {
    Unoccupied              (0),
    RemoteContactOccupied  (1),
    NormalScheduleOccupied (2),
    PushButtonOrZoneOverride (3),
    HolidayModeActive      (4),
    UnoccupiedZoneDemand   (5),
    RemoteScheduleOverride (6),
    CurrentOutputForceMode (7),
    SATHighOrLowCutOff     (8),
    CO2OverrideInProgress  (9),
    PurgeModeActive        (10)
}
    
```

```

VcmxControlStatusBits ::= ENUMERATED {
    Off          (0),
    Vent         (1),
    Cool         (2),
    Heat         (3),
    Dehum        (4),
    Dehum Cool   (5),
    Dehum Heat   (6),
    Warm Up Mode (7),
    Defrost      (8)
}
    
```

```

VcmxOnBoardRelaysBits ::= BIT STRING {
    OnBoardRelay1 (0),
    OnBoardRelay2 (1),
    OnBoardRelay3 (2),
    OnBoardRelay4 (3),
    OnBoardRelay5 (4)
}
    
```

```

VcmxExternal Relays1-2Bits ::= BIT STRING {
    ExpansionBoard1Relay1 (0),
    ExpansionBoard1Relay2 (1),
    ExpansionBoard1Relay3 (2),
    ExpansionBoard1Relay4 (3),
    ExpansionBoard2Relay1 (4),
    ExpansionBoard2Relay2 (5),
    ExpansionBoard2Relay3 (6),
    ExpansionBoard2Relay4 (7)
}
    
```

```

VcmxExternal Relays2-4Bits ::= BIT STRING {
    ExpansionBoard3Relay1 (0),
    ExpansionBoard3Relay2 (1),
    ExpansionBoard3Relay3 (2),
    ExpansionBoard3Relay4 (3),
    ExpansionBoard4Relay1 (4),
    ExpansionBoard4Relay2 (5),
    ExpansionBoard4Relay3 (6),
    ExpansionBoard4Relay4 (7)
}
    
```

```

VcmxAlarmStatusBits ::= BIT STRING {
    Alarm Group1 (0),
    Alarm Group2 (1),
    Alarm Group3 (2),
    Alarm Group4 (3),
    Alarm Group5 (4)
}
    
```

```

VcmxAlarmGroup1Bits ::= BIT STRING {
    SupplyTempSensorFailure (0),
    LostOutdoorTempSensorSignal (1),
    LostSpaceTempSensorSignal (2),
    ModuleAlarm (3),
    DemandVentilationAlarm (4),
    OutdoorCFMSensorFailure (5),
    ReturnTempSensorFailure (6)
}
    
```

```

VcmxAlarmGroup2Bits ::= BIT STRING {
    MechanicalCoolingAlarm (0),
    MechanicalHeatingAlarm (1),
    FanProvingAlarm (2),
    DirtyFilterDetected (3),
    SmokeDetected (4)
}
    
```

```

VcmxAlarmGroup3Bits ::= BIT STRING {
    LowSupplyAirTempAlarm (0),
    HighSupplyAirTempAlarm (1),
    LowControlTempAlarm (2),
    HighControlTempAlarm (3)
}
    
```

```

VcmxAlarmGroup5Bits ::= BIT STRING {
    AirTempSensorFailure (0),
    NoEconWhenItShould (1),
    EconWhenItShouldNot (2),
    DamperFailure (3),
    ExcessOutdoorAir (4)
}
    
```

BACNET AND DATA ARRAY INFORMATION

SA Controller

BACnet Properties and PT-Link Data Array Cross Reference

BACNET PROPERTIES AND PT-LINK DATA ARRAY CROSS REFERENCE FOR SA						
Parameter	Data Array Block	Name	Object	Description	Limits	
Application Software Version	000 (0:0)	AppVer	AI: 99	Current version of the software in the unit.		
Occupied Mode Enable Cooling Setpoint Mirror	001 (0:1)	ClSt	AI: 7	Occupied Mode Enable Cooling Setpoint mirror.		
Occupied Mode Enable Heating Setpoint Mirror	002 (0:2)	HtSt	AI: 31	Occupied Mode Enable Heating Setpoint mirror.		
Temperature Demand	003 (0:3)	TpDmnd	AI: 84	Based on the comparison between the current control temperature and the Heating or Cooling Setpoint temperatures. Does not work for supply air control.		
Space Temperature	004 (0:4)	SpcTp	AI: 72	Current value of the Space Temperature Sensor.		
Supply Air Temperature	005 (0:5)	SaTp	AI: 83	Current value of the Supply Air Temperature Sensor.		
Duct Static Pressure	006 (0:6)	DuctPr	AI: 14	Current value of the Duct Static Pressure Sensor.		
Unit Mode	007 (0:7)	UnitMode	AI: 123		See Unit Mode Bits on page 67.	
Control Status	008 (0:8)	CtrlSts	AI: 4	Current operational status.	See Control Status Bits on page 67.	
Cooling Enabled	009 (0:9)	ClEnbl	BI: 6	Status that indicates mechanical cooling is enabled.		
Heating Enabled	010 (10:0)	HtEnbl	BI: 30	Status that indicates that mechanical heating is enabled.		
Economizer Enabled	011 (10:1)	EcoEnbl	BI: 15	Status that indicates the economizer is enabled.		
Fan Start Up Delay	012 (10:2)	FanDly	BI: 25	Status that indicates the fan is commanded to run, but it is in the start up delay mode.		
MODGAS II Connected	013 (10:3)	MdHt2Ins	BI: 39	Status that indicates the MODGAS II controller is connected.		
REHEAT II Connected	014 (10:4)	Rt2Ins	BI: 58	Status that indicates the MHGRV controllers is connected to the system.		
Economizer Position	015 (10:5)	EcoPos	AI: 16	Current position of the waterside economizer valve.		
VFD Blower Fan	016 (10:6)	VfdBwPos	AI: 88	Current position of the VFD blower fan signal.		
Bad Supply Air Sensor	017 (10:7)	SaTpAlm	BI: 2	Alarm that indicates a failure in the Supply Air Sensor.		
Space Temperature Sensor Lost	018 (10:8)	SpcTpAlm	BI: 101	Alarm that indicates a failure in the Space Temperature Sensor.		
Mechanical Cooling Alarm	019 (10:9)	MchClAlm	BI: 94	Compressor relays are enabled but the supply air temperature has not fallen 5°F within a user-adjustable time period. This does not indicate compressors are active and will not shut the unit down.		

Objects labeled AI and BI are read-only. Objects labeled AV are read/write. Sensor Inputs are read-only.

BACNET AND DATA ARRAY INFORMATION

SA Controller

BACNET PROPERTIES AND PT-LINK DATA ARRAY CROSS REFERENCE FOR SA						
Parameter	Data Array Block	Name	Object	Description	Limits	
Mechanical Heating Alarm	020 (20:0)	MchHtAlm	BI: 95	Heating Mode has been initiated but the supply air temperature has not risen 5°F within a user-adjustable time period. This does not indicate heat stages are active and will not shut the unit down.		
Fan Proving Alarm	021 (20:1)	PofAlm	BI: 26	Alarm that indicates a failure in the flow of the VFD blower.		
Dirty Filter Detected	022 (20:2)	DrtFIAlm	BI: 96	Alarm that indicates the filters are dirty.		
Low Supply Air Temperature Alarm	023 (20:3)	LoSaAlm	BI: 37	The supply air has fallen below the Hi SAT Cutoff Setpoint and cooling stages will begin to deactivate. If the unit is in Economizer, Vent, or Heating Mode the supply fan will shut off.		
High Supply Air Temperature Alarm	024 (20:4)	HiSaAlm	BI: 33	The supply air has risen above the Hi SAT Cutoff Setpoint. Heating stages begin to deactivate and the fan continues to run.		
Control Temperature Cool Failure	025 (20:5)	CtrlTpCF	BI: 108	This alarm is activated if the control temperature does not get within 5°F to the Occupied Cooling Setpoint in an hour in the Cooling Mode. This alarm is not used in 100% outdoor air units or supply air control.		
Control Temperature Heat Failure	026 (20:6)	CtrlTpHF	BI: 109	This alarm is activated if the control temperature does not get within 5°F to the Occupied Heating Setpoint in an hour in the Heating Mode. This alarm is not used in 100% outdoor air units or supply air control.		
Control Temperature	027 (20:7)	CtrlTp	AI: 9	Current value of the control temperature sensor.		
Indoor Humidity	028 (20:8)	InRh	AI: 67	Current value of the Indoor Humidity Sensor.		
Indoor RH Setpoint Mirror	029 (20:9)	InRhStM	AI: 114	Mirror of the InRhSt "read only."		
Dewpoint Setpoint Mirror	030 (30:0)	DptStM	AI: 110	Mirror of the DPTSt "read only."		
Modulating Cool Position	031 (30:1)	MdCIPos	AI: 115	Current position of the modulating cooling signal (chilled water or digital compressor).		
Modulating Heat Position	032 (30:2)	MdHtPos	AI: 116	Current position of the modulating heating signal (hot water or SCR heat).		
Modulating Gas Valve Position	033 (30:3)	MdHt2Pos	AI: 38	Current position of MODGAS II modulating gas valve control.		
Reheat Value Position	034 (30:4)	Rt2Pos	AI: 60	Current position of MHGRV modulating hot gas reheat valve control.		
Occupied Mode Enable Cooling Setpoint	035 (30:5)	OcpCISt	AV: 42	If the control temperature rises one degree above this setpoint, the control will activate the cooling demand. If the control temperature is the Supply Air Sensor, then the cooling demand is always active.	0	99

Objects labeled AI and BI are read-only. Objects labeled AV are read/write. Sensor Inputs are read-only.

BACNET AND DATA ARRAY INFORMATION

SA Controller

BACNET PROPERTIES AND PT-LINK DATA ARRAY CROSS REFERENCE FOR SA						
Parameter	Data Array Block	Name	Object	Description	Limits	
Occupied Mode Enable Heating Setpoint	036 (30:6)	OcpHtSt	AV: 43	If the control temperature drops one degree below this setpoint, the control will activate the heating demand. If the control temperature is the Supply Air Sensor, then there is no heating demand.		99
Unoccupied Cooling Offset	037 (30:7)	UnClOst	AV: 124	During the Unoccupied Mode of operation, this setpoint spreads the Occupied Cooling Setpoint out by a user-adjustable amount. If you do not want cooling to operate during the Unoccupied Mode, use the default setting of 30°F for these setpoints.	0	30
Unoccupied Heating Offset	038 (30:8)	UnHtOst	AV: 125	During the Unoccupied Mode of operation, this setpoint spreads the Occupied Heating Setpoint out by a user-adjustable amount. If you do not want heating to operate during the Unoccupied Mode, use the default setting of 30°F for these setpoints.	0	30
SAT Cooling Setpoint	039 (30:9)	SaClSt	AV: 77	Supply Air Setpoint in Cooling Mode.	40	80
Supply Air Heat High Reset	040 (40:0)	SaHtRt	AV: 325	High supply air heating reset limit.	40	150
Warm Up Setpoint	041 (40:1)	WmupSt	AV: 91	In a VAV application, upon entering the Occupied Mode, the warm-up demand will be activated if the return air temperature falls one degree below this setpoint.	50	90
Space Sensor Offset	042 (40:2)	SpcTpOst	AV: 71	If the Space Temperature Sensor is reading incorrectly, you can use this option to enter an offset temperature to adjust the sensor's temperature.	-100	100
Supply Air Sensor Offset	043 (40:3)	SaTpOst	AV: 80	If the Supply Air Temperature Sensor is reading incorrectly, you can use this option to enter an offset temperature to adjust the sensor's temperature.	-100	100
Coil Temperature Setpoint	044 (40:4)	CoilTpSt	AI: 107	Current Coil Temperature Setpoint.		
Dewpoint Setpoint	045 (40:5)	DptSt	AV: 13	If the outdoor dewpoint rises above this setpoint, the unit will activate the dehumidification demand.	35	80
Indoor Humidity Setpoint	046 (40:6)	InRhSt	AV: 120	If the indoor humidity rises above this setpoint, the unit will activate the dehumidification demand.	0	100
Static Pressure Setpoint	047 (40:7)	DuctPrSt	AV: 152	This is the target duct pressure to be maintained by the VFD blower signal.	0.01	3
Schedule Force	048 (40:8)	SchdFrc	AV: 66	0 = Auto/Unoccupied Mode 1 = Forced On 2 = Forced Off	0	2
On Board Relay 1	049 (40:9)	OnRly1	BI: 127	Current status of relay 1.		
On Board Relay 2	050 (50:0)	OnRly2	BI: 128	Current status of relay 2.		
On Board Relay 3	051 (50:1)	OnRly3	BI: 129	Current status of relay 3.		

Objects labeled AI and BI are read-only. Objects labeled AV are read/write. Sensor Inputs are read-only.

BACNET AND DATA ARRAY INFORMATION

SA Controller

BACNET PROPERTIES AND PT-LINK DATA ARRAY CROSS REFERENCE FOR SA

Parameter	Data Array Block	Name	Object	Description	Limits	
On Board Relay 4	052 (50:2)	OnRly4	BI: 130	Current status of relay 4.		
On Board Relay 5	053 (50:3)	OnRly5	BI: 131	Current status of relay 5.		
Expansion Relay 1	054 (50:4)	ExRly1	BI: 133	Current status of relay 6.		
Expansion Relay 2	055 (50:5)	ExRly2	BI: 134	Current status of relay 7.		
Expansion Relay 3	056 (50:6)	ExRly3	BI: 135	Current status of relay 8.		
Expansion Relay 4	057 (50:7)	ExRly4	BI: 136	Current status of relay 9.		
Expansion Relay 5	058 (50:8)	ExRly5	BI: 137	Current status of relay 10.		
Expansion Relay 6	059 (50:9)	ExRly6	BI: 138	Current status of relay 11.		
Expansion Relay 7	060 (60:0)	ExRly7	BI: 139	Current status of relay 12.		
Expansion Relay 8	061 (60:1)	ExRly8	BI: 140	Current status of relay 13.		
Expansion Relay 9	062 (60:2)	ExRly9	BI: 141	Current status of relay 14.		
Expansion Relay 10	063 (60:3)	ExRly10	BI: 142	Current status of relay 15.		
Expansion Relay 11	064 (60:4)	ExRly11	BI: 143	Current status of relay 16.		
Expansion Relay 12	065 (60:5)	ExRly12	BI: 144	Current status of relay 17.		
Expansion Relay 13	066 (60:6)	ExRly13	BI: 145	Current status of relay 18.		
Expansion Relay 14	067 (60:7)	ExRly14	BI: 146	Current status of relay 19.		
Expansion Relay 15	068 (60:8)	ExRly15	BI: 147	Current status of relay 20.		
Expansion Relay 16	069 (60:9)	ExRly16	BI: 148	Current status of relay 21.		
Coil Temperature	070 (70:0)	CoilTp	AI: 181	Current coil temperature reading added on version 1.09.		
Current Supply Air Setpoint	071 (70:1)	SaTpStM	AI: 82	Current SAT Cooling or Heating Setpoint if there is no reset source. Current calculated SAT Setpoint with reset source.		
Preheater Setpoint	072 (70:2)	PreHtSp	AV: 196	Low Outdoor Air Ambient Protection Setpoint.	0	100
Entering Air Temperature	073 (70:3)	EaTp	AI: 235	Temperature of the air that is entering the unit.		
Entering Water Temperature	074 (70:4)	EwTp	AI: 236	Temperature of the water that is entering the unit.		
Entering Air Humidity	075 (70:5)	EaRh	AI: 237	Relative humidity of the entering air.		

Objects labeled AI and BI are read-only. Objects labeled AV are read/write. Sensor Inputs are read-only.

BACNET AND DATA ARRAY INFORMATION

SA Controller

BACNET PROPERTIES AND PT-LINK DATA ARRAY CROSS REFERENCE FOR SA

Parameter	Data Array Block	Name	Object	Description	Limits	
Head Pressure 1	076 (70:6)	HdPr1	AI: 207	Head pressure for first unit.		
Head Pressure 2	077 (70:7)	HdPr2	AI: 208	Head pressure for second unit.		
Coil Temperature 2	078 (70:8)	CoilTp2	AI: 240	Current coil temperature for second unit.		
Entering Air Dewpoint	079 (70:9)	EaDpt	AI: 241	Current entering air dewpoint		
Water Side Economizer Bypass	080 (80:0)	WSEByp	AI: 242	Current water side economizer bypass position for first unit.		
Water Side Economizer Bypass 2	081 (80:1)	WSEByp2	AI: 243	Current water side economizer bypass position for second unit.		
Coil Temperature Setpoint	082 (80:2)	CoilTpSt	AV: 107	This is the coil suction temperature target during Dehumidification Mode. Produces dewpoint in the supply air approximately 10°F above this setpoint.	35	70
Modulating Compressor 2 Position	083 (80:3)	MdCmp2	AI: 206	Current position of the second stage of compressor modulation.		
Condenser Position 1	084 (80:4)	CdPos1	AI: 246	Current condenser position for first unit.		
Condenser Position 2	085 (80:5)	CdPos2	AI: 247	Current condenser position for second unit.		
Entering Air Temperature Alarm	086 (80:6)	EaTpAlm	BI: 248	Alarm that indicates failure in the Entering Air Temperature Sensor.		
Emergency Shutdown Alarm	087 (80:7)	EmerAlm	BI: 219	Alarm that indicates emergency shutdown.		
Proof of Water Flow Alarm	088 (80:8)	PoWFAlm	BI: 245	Alarm that indicates no proof of water flow.		
Drain Pan Overflow	089 (80:9)	DrnAlm	BI: 244	Alarm that indicates overflow of the drain pan.		
Entering Air Offset Setpoint	090 (90:0)	EaTpOst	AV: 238	If the Entering Air Temperature Sensor is reading incorrectly, you can use this option to enter an offset temperature to adjust the sensor's temperature.		
Entering Water Offset Setpoint	091 (90:1)	EwTpOst	AV: 239	If the Entering Water Temperature Sensor is reading incorrectly, you can use this option to enter an offset temperature to adjust the sensor's temperature.		
Supply Air Cool High Reset	092 (90:2)	SaCIRt	AV: 324	High supply air cooling reset limit	40	150
SAT Heating Setpoint	093 (90:3)	SaHtSt	AV: 78	Supply Air Setpoint in Heating Mode.	40	200
Cooling Low Reset Source	094 (90:4)	ClLoRt	AV: 326	Low Cool Reset Source Setpoint.	1	150
Cooling High Reset Source	095 (90:5)	ClHiRt	AV: 327	High Cool Reset Source Setpoint.	1	150
Heating Low Reset Source	096 (90:6)	HtLoRt	AV: 328	Low Heat Reset Source Setpoint.	1	150
Heating High Reset Source	097 (90:7)	HtHiRt	AV: 329	High Heat Reset Source Setpoint.	1	150

Objects labeled AI and BI are read-only. Objects labeled AV are read/write. Sensor Inputs are read-only.

SA Controller

SA Controller Property Identifier

The PT-Link-BACnet Link amends the following property identity to the BACnet property identifier.

```
SAUnitMode ::= ENUMERATED {  
    Unoccupied (0),  
    RemoteContactOccupied (1),  
    NormalScheduleOccupied (2),  
    PushButtonOrZoneOverride (3),  
    HolidayModeActive (4),  
    UnoccupiedZoneDemand (5),  
    RemoteScheduleOverride (6),  
    CurrentOutputForceMode (7),  
    SATHighOrLowCutOff (8),  
    CO2OverrideInProgress (9),  
    PurgeModeActive (10)  
}
```

```
SAControlStatusBits ::= ENUMERATED {  
    Off (0),  
    Vent (1),  
    Cool (2),  
    Heat (3),  
    Dehum (4),  
    Dehum Cool (5),  
    Dehum Heat (6),  
    Warm Up Mode (7)  
}
```

BACNET AND DATA ARRAY INFORMATION

VCM Controller

BACnet Properties and PT-Link Data Array Cross Reference

BACNET PROPERTIES AND PT-LINK DATA ARRAY CROSS REFERENCE FOR VCM						
Parameter	Data Array Block	Name	Object	Description	Limits	
Application Software Version	000 (0:0)	AppVer	AI: 99	Current version of the software in the unit.		
Occupied Mode Enable Cooling Setpoint Mirror	001 (0:1)	ClSt	AI: 7	Occupied Mode Enable Cooling Setpoint mirror.		
Occupied Mode Enable Heating Setpoint Mirror	002 (0:2)	HtSt	AI: 31	Occupied Mode Enable Heating Setpoint mirror.		
Outdoor Air Wetbulb	003 (0:3)	OaWtbl	AI: 55	Current calculated value of the outdoor wetbulb temperature.		
Temperature Demand	004 (0:4)	TpDmnd	AI: 84	Based on the comparison between the current control temperature and the Heating or Cooling Setpoint temperatures. Does not work for supply air control.		
Space Temperature	005 (0:5)	SpcTp	AI: 72	Current value of the Space Temperature Sensor.		
Supply Air Temperature	006 (0:6)	SaTp	AI: 83	Current value of the Supply Air Temperature Sensor.		
Return Air Temperature	007 (0:7)	RaTp	AI: 64	Current value of the Return Temperature Sensor.		
Outdoor Air Temperature	008 (0:8)	OaTp	AI: 54	Current value of the Outdoor Temperature Sensor.		
Duct Static Pressure	009 (0:9)	DuctPr	AI: 14	Current value of the Duct Static Pressure Sensor.		
Outdoor Air Humidity	010 (10:0)	OaRh	AI: 52	Current value of the Outdoor Humidity Sensor.		
Unit Mode	011 (10:1)	UnitMode	AI: 123		See Unit Mode Bits on page 74.	
Control Status	012 (10:2)	CtrlSts	AI: 4	Current operational status.		
Cooling Demand	013 (10:3)	ClDmnd	BI: 5	Status that indicates a demand for cooling.		
Heating Demand	014 (10:4)	HtDmnd	BI: 29	Status that indicates a demand for heating.		
Dehumidification Demand	015 (10:5)	DehmDmnd	BI: 113	Status that indicates a demand for dehumidification.		
Cooling Enabled	016 (10:6)	ClEnbl	BI: 6	Status that indicates mechanical cooling is enabled.		
Heating Enabled	017 (10:7)	HtEnbl	BI: 30	Status that indicates that mechanical heating is enabled.		
Economizer Enabled	018 (10:8)	EcoEnbl	BI: 15	Status that indicates the economizer is enabled.		
Fan Start Up Delay	019 (10:9)	FanDly	BI: 25	Status that indicates the fan is commanded to run, but it is in the Start Up Delay Mode.		
Warm Up Mode Active	020 (20:0)	WmupDmnd	BI: 90	Status that indicates the control is in the Warm-Up Mode.		
Proof of Flow Configured	021 (20:1)	PofCfg	BI: 57	Status that indicates the proof of flow function has been configured.		

Objects labeled AI and BI are read-only. Objects labeled AV are read/write. Sensor Inputs are read-only.

BACNET AND DATA ARRAY INFORMATION

VCM Controller

BACNET PROPERTIES AND PT-LINK DATA ARRAY CROSS REFERENCE FOR VCM						
Parameter	Data Array Block	Name	Object	Description	Limits	
CO ₂ Sensor Installed	022 (20:2)	CO2Cfg	BI: 3	Status indicates the CO ₂ function has been configured.		
MODGAS II Connected	023 (20:3)	MdHt2Ins	BI: 39	Status indicates the MODGAS II Controller is connected.		
REHEAT II Connected	024 (20:4)	Rt2Ins	BI: 58	Status indicates the MHGRV Controller is connected to the system.		
On Board Relays	025 (20:5)	OnRlys	AI: 44		See On Board Relays Bits on page 74.	
External Relays 1-2	026 (20:6)	ExRlys12	AI: 111		See External Relays Bits on page 74.	
External Relays 3-4	027 (20:7)	ExRlys34	AI: 112		See External Relays Bits on page 74.	
Economizer Position	028 (20:8)	EcoPos	AI: 16	Current position of the economizer damper.		
VFD Blower Fan	029 (20:9)	VfdBwPos	AI: 88	Current position of the VFD blower fan signal.		
VFD Relief Fan	030 (30:0)	VfdExPos	AI: 89	Current position of the VFD relief fan signal.		
Alarm Status	031 (30:1)	AlmSts	AI: 1		See Alarm Status Bits on page 74.	
Alarm Group 1	032 (30:2)	AlmGrp1	AI: 104		See Alarm Status Bits on page 74.	
Alarm Group 2	033 (30:3)	AlmGrp2	AI: 105		See Alarm Status Bits on page 74.	
Alarm Group 3	034 (30:4)	AlmGrp3	AI: 106		See Alarm Status Bits on page 74.	
Bad Supply Air Sensor	035 (30:5)	SaTpAlm	BI: 2	Alarm indicates a failure in the Supply Air Sensor.		
Outdoor Air Temperature Lost	036 (30:6)	OaTpAlm	BI: 117	Alarm indicates a failure in the Outdoor Air Temperature.		
Space Temperature Sensor Lost	037 (30:7)	SpcTpAlm	BI: 101	Alarm indicates a failure in the Space Temperature Sensor.		
Mechanical Cooling Alarm	038 (30:8)	MchClAlm	BI: 94	Compressor relays are enabled but the supply air temperature has not fallen 5°F within a user-adjustable time period. This does not indicate compressors are active and will not shut the unit down.		
Mechanical Heating Alarm	039 (30:9)	MchHtAlm	BI: 95	Heating Mode has been initiated but the supply air temperature has not risen 5°F within a user-adjustable time period. This does not indicate heat stages are active and will not shut the unit down.		
Fan Proving Alarm	040 (40:0)	PofAlm	BI: 26	Alarm indicates a failure in the flow of the VFD blower.		
Dirty Filter Detected	041 (40:1)	DrtFIAlm	BI: 96	Alarm indicates the filters are dirty.		
Smoke Detector Alarm	042 (40:2)	SmokeAlm	BI: 119	Alarm indicates the Smoke Sensor has been activated.		
Objects labeled AI and BI are read-only. Objects labeled AV are read/write. Sensor Inputs are read-only.						

BACNET AND DATA ARRAY INFORMATION

VCM Controller

BACNET PROPERTIES AND PT-LINK DATA ARRAY CROSS REFERENCE FOR VCM						
Parameter	Data Array Block	Name	Object	Description	Limits	
Low Supply Air Temperature Alarm	043 (40:3)	LoSaAlm	BI: 37	The supply air has fallen below the Hi SAT Cutoff Setpoint and cooling stages will begin to deactivate. If the unit is in Economizer, Vent, or Heating Mode the supply fan will shut off.		
High Supply Air Temperature Alarm	044 (40:4)	HiSaAlm	BI: 33	The supply air has risen above the Hi SAT Cutoff Setpoint. Heating stages begin to deactivate and the fan continues to run.		
Control Temperature Cool Failure	045 (40:5)	CtrlTpCF	BI: 108	This alarm is activated if the control temperature does not get within 5°F to the Occupied Cooling Setpoint in an hour in the Cooling Mode. This alarm is not used in 100% outdoor air units or supply air control.		
Control Temperature Heat Failure	046 (40:6)	CtrlTpHF	BI: 109	This alarm is activated if the control temperature does not get within 5°F to the Occupied Heating Setpoint in an hour in the Heating Mode. This alarm is not used in 100% outdoor air units or supply air control.		
Control Temperature	047 (40:7)	CtrlTp	AI: 9	Current value of the Control Temperature Sensor.		
Indoor Humidity	048 (40:8)	InRh	AI: 67	Current value of the Indoor Humidity Sensor.		
Indoor RH Setpoint Mirror	049 (40:9)	InRhStM	AI: 114	Mirror of the InRhSt "read only."		
Dewpoint Setpoint Mirror	050 (50:0)	DptStM	AI: 110	Mirror of the DPTst "read only."		
Modulating Cool Position	051 (50:1)	MdCIPos	AI: 115	Current position of the modulating cooling signal (chilled water or digital compressor).		
Modulating Heat Position	052 (50:2)	MdHtPos	AI: 116	Current position of the modulating heating signal (hot water or SCR heat).		
Modulating Gas Valve Position	053 (50:3)	MdHt2Pos	AI: 38	Current position of MODGAS II modulating gas valve control.		
Reheat Value Position	054 (50:4)	Rt2Pos	AI: 60	Current position of MHGRV modulating hot gas reheat valve control.		
Occupied Mode Enable Cooling Setpoint	055 (50:5)	OcpClSt	AV: 42	If the control temperature rises one degree above this setpoint, the control will activate the cooling demand. If the control temperature is the Supply Air Sensor, then the cooling demand is always active.	0	99
Occupied Mode Enable Heating Setpoint	056 (50:6)	OcpHtSt	AV: 43	If the control temperature drops one degree below this setpoint, the control will activate the heating demand. If the control temperature is the Supply Air Sensor, then there is no heating demand.	0	99

Objects labeled AI and BI are read-only. Objects labeled AV are read/write. Sensor Inputs are read-only.

BACNET AND DATA ARRAY INFORMATION

VCM Controller

BACNET PROPERTIES AND PT-LINK DATA ARRAY CROSS REFERENCE FOR VCM						
Parameter	Data Array Block	Name	Object	Description	Limits	
Unoccupied Cooling Offset	057 (50:7)	UnClOst	AV: 124	During the Unoccupied Mode of operation, this setpoint spreads the Occupied Cooling Setpoint out by a user-adjustable amount. If you do not want cooling to operate during the Unoccupied Mode, use the default setting of 30°F for these setpoints.	0	30
Unoccupied Heating Offset	058 (50:8)	UnHtOst	AV: 125	During the Unoccupied Mode of operation, this setpoint spreads the Occupied Heating Setpoint out by a user-adjustable amount. If you do not want heating to operate during the Unoccupied Mode, use the default setting of 30°F for these setpoints.	0	30
Wet Bulb Setpoint	058 (50:9)	WtBlSt	AV: 92	The economizer is enabled if the outdoor temperature or wetbulb falls below this setpoint.	0	80
SAT/Reset Source Cooling Setpoint	060 (60:0)	SaClSt	AV: 77	Supply Air Setpoint or reset source target temperature in Cooling Mode.	40	80
SAT/Reset Source Heating Setpoint	061 (60:1)	SaHtSt	AV: 78	Supply Air Setpoint or reset source target temperature in Heating Mode.	40	200
Warm Up Setpoint	062 (60:2)	WmupSt	AV: 91	In a VAV application, upon entering the Occupied Mode, the warm-up demand will be activated if the return air temperature falls one degree below this setpoint.	50	90
Space Sensor Offset	063 (60:3)	SpcTpOst	AV: 71	If the Space Temperature Sensor is reading incorrectly, you can use this option to enter an offset temperature to adjust the sensor's temperature.	-100	100
Supply Air Sensor Offset	064 (60:4)	SaTpOst	AV: 80	If the Supply Air Temperature Sensor is reading incorrectly, you can use this option to enter an offset temperature to adjust the sensor's temperature.	-100	100
Return Air Sensor Offset	065 (60:5)	RaTpOst	AV: 65	If the Return Temperature Sensor is reading incorrectly, you can use this option to enter an offset temperature to adjust the sensor's temperature.	-100	100
Outdoor Air Sensor Offset	066 (60:6)	OaTpOst	AV: 53	If the Outdoor Temperature Sensor is reading incorrectly, you can use this option to enter an offset temperature to adjust the sensor's temperature.	-100	100
Coil Temperature Setpoint	067 (60:7)	CoilTpSt	AV: 107	This is the coil suction temperature target during Dehumidification Mode. Produces dewpoint in the supply air approximately 10°F above this setpoint.	35	70
Dewpoint Setpoint	068 (60:8)	DptSt	AV: 13	If the outdoor dewpoint rises above this setpoint, the unit will activate the dehumidification demand.	35	80
Indoor Humidity Setpoint	069 (60:9)	InRhSt	AV: 120	If the indoor humidity rises above this setpoint, the unit will activate the dehumidification demand.	0	100
Static Pressure Setpoint	070 (70:0)	DuctPrSt	AV: 152	This is the target duct pressure to be maintained by the VFD blower signal.	0.01	3

Objects labeled AI and BI are read-only. Objects labeled AV are read/write. Sensor Inputs are read-only.

BACNET AND DATA ARRAY INFORMATION

VCM Controller

BACNET PROPERTIES AND PT-LINK DATA ARRAY CROSS REFERENCE FOR VCM						
Parameter	Data Array Block	Name	Object	Description	Limits	
Relief Pressure Setpoint	071 (70:1)	RfPrSt	AV: 118	This is the target building pressure to be maintained by the VFD relief signal.	-0.2	0.2
Schedule Force	072 (70:2)	SchdFrc	AV: 66	0 = Auto/Unoccupied Mode 1 = Forced On 2 = Forced Off	0	2
On Board Relay 1	073 (70:3)	OnRly1	BI: 127	Current status of relay 1.		
On Board Relay 2	074 (70:4)	OnRly2	BI: 128	Current status of relay 2.		
On Board Relay 3	075 (70:5)	OnRly3	BI: 129	Current status of relay 3.		
On Board Relay 4	076 (70:6)	OnRly4	BI: 130	Current status of relay 4.		
On Board Relay 5	077 (70:7)	OnRly5	BI: 131	Current status of relay 5.		
Expansion Relay 1	078 (70:8)	ExRly1	BI: 133	Current status of relay 6.		
Expansion Relay 2	079 (70:9)	ExRly2	BI: 134	Current status of relay 7.		
Expansion Relay 3	080 (80:0)	ExRly3	BI: 135	Current status of relay 8.		
Expansion Relay 4	081 (80:1)	ExRly4	BI: 136	Current status of relay 9.		
Expansion Relay 5	082 (80:2)	ExRly5	BI: 137	Current status of relay 10.		
Expansion Relay 6	083 (80:3)	ExRly6	BI: 138	Current status of relay 11.		
Expansion Relay 7	084 (80:4)	ExRly7	BI: 139	Current status of relay 12.		
Expansion Relay 8	085 (80:5)	ExRly8	BI: 140	Current status of relay 13.		
Expansion Relay 9	086 (80:6)	ExRly9	BI: 141	Current status of relay 14.		
Expansion Relay 10	087 (80:7)	ExRly10	BI: 142	Current status of relay 15.		
Expansion Relay 11	088 (80:8)	ExRly11	BI: 143	Current status of relay 16.		
Expansion Relay 12	089 (80:9)	ExRly12	BI: 144	Current status of relay 17.		
Expansion Relay 13	090 (90:0)	ExRly13	BI: 145	Current status of relay 18.		
Expansion Relay 14	091 (90:1)	ExRly14	BI: 146	Current status of relay 19.		
Expansion Relay 15	092 (90:2)	ExRly15	BI: 147	Current status of relay 20.		
Expansion Relay 16	093 (90:3)	ExRly16	BI: 148	Current status of relay 21.		

Objects labeled AI and BI are read-only. Objects labeled AV are read/write. Sensor Inputs are read-only.

BACNET AND DATA ARRAY INFORMATION

VCM Controller

BACNET PROPERTIES AND PT-LINK DATA ARRAY CROSS REFERENCE FOR VCM						
Parameter	Data Array Block	Name	Object	Description	Limits	
CO ₂ Setpoint	094 (90:4)	CO2St	AV: 149	When the CO ₂ level rises above the CO ₂ protection limit max level, the economizer's minimum position will begin to reset open proportionally between the CO ₂ Protection Limit Max Level Setpoint and the Reset Range Setpoint.	0	3000
Minimum Outdoor Air Setpoint	095 (90:5)	MinEcoSt	AV: 151	This is the minimum position of the economizer in the Occupied Modes.	1	100
Return Air CO ₂ Level	096 (90:6)	CO2Level	AI: 150	Current value of the CO ₂ Sensor.		
Bypass Damper Position	097 (90:7)	ByPasDmp	AI: 153	Current position of the bypass damper signal.		
Return Damper Position	098 (90:8)	RaDmp	AI: 154	Current position of the return damper signal.		
Relief Pressure	099 (90:9)	RfPr	AI: 62	Current value of the Building Pressure Sensor.		
Outdoor Air Dewpoint	100 (100:0)	OaDwpt	AI: 47	Current calculated outdoor air dewpoint added on version 1.09.		
Coil Temperature	101 (100:1)	CoilTp	AI: 181	Current coil temperature reading added on version 1.09.		
Current Supply Air Setpoint	102 (100:2)	SaTpStM	AI: 82	Current SAT Cooling or Heating Setpoint if there is no reset source. Current calculated SAT Setpoint with reset source.		
Preheater Setpoint	103 (100:3)	PreHtSp	AV: 196	Low Outdoor Air Ambient Protection Setpoint	0	100

Objects labeled AI and BI are read-only. Objects labeled AV are read/write. Sensor Inputs are read-only.

VCM Controller

VCM BACnet Property Identifier

The PT-Link II BACnet Link amends the following property identity to the BACnet property identifier.

```
WattBACNETScheduleForce ::= ENUMERATED {  
    NormalOperation           (0),  
    ForceOccupied             (1),  
    ForceUnoccupied           (2)  
}
```

```
VcmUnitMode ::= ENUMERATED {  
    Unoccupied                 (0),  
    RemoteContactOccupied     (1),  
    NormalScheduleOccupied    (2),  
    PushButtonOrZoneOverride (3),  
    HolidayModeActive         (4),  
    UnoccupiedZoneDemand      (5),  
    RemoteScheduleOverride    (6),  
    CurrentOutputForceMode    (7),  
    SATHighOrLowCutOff        (8),  
    CO2OverrideInProgress     (9),  
    PurgeModeActive           (10)  
}
```

```
VcmControlStatusBits ::= BIT STRING {  
    Cool Demand                (0),  
    Heat Demand                (1),  
    DehumidificationMode      (2),  
    Cooling Enabled            (3),  
    Heating Enabled            (4),  
    Economizer Enabled         (5),  
    Fan Start-up Delay         (6),  
    Warm-up Mode Active       (7),  
    Fan Proving                (8),  
    RH Priority                 (9),  
    CarbonDioxideSensorPresent (10),  
    ModGasIICConnected        (11),  
    ReheatIICConnected        (12)  
}
```

```
VcmOnBoardRelaysBits ::= BIT STRING {  
    OnBoardRelay1             (0),  
    OnBoardRelay2             (1),  
    OnBoardRelay3             (2),  
    OnBoardRelay4             (3),  
    OnBoardRelay5             (4)  
}
```

```
VcmExternal Relays1-2Bits ::= BIT STRING {  
    ExpansionBoard1Relay1     (0),  
    ExpansionBoard1Relay2     (1),  
    ExpansionBoard1Relay3     (2),  
    ExpansionBoard1Relay4     (3),  
    ExpansionBoard2Relay1     (4),  
    ExpansionBoard2Relay2     (5),  
    ExpansionBoard2Relay3     (6),  
    ExpansionBoard2Relay4     (7)  
}
```

```
VcmExternal Relays2-4Bits ::= BIT STRING {  
    ExpansionBoard3Relay1     (0),  
    ExpansionBoard3Relay2     (1),  
    ExpansionBoard3Relay3     (2),  
    ExpansionBoard3Relay4     (3),  
    ExpansionBoard4Relay1     (4),  
    ExpansionBoard4Relay2     (5),  
    ExpansionBoard4Relay3     (6),  
    ExpansionBoard4Relay4     (7)  
}
```

```
VcmAlarmStatusBits ::= BIT STRING {  
    Alarm Group1              (0),  
    Alarm Group2              (1),  
    Alarm Group3              (2)  
}
```

Check Wiring and Settings

No COMS on AAON side

If TX/RX are not flashing rapidly, then there is a COM issue on the AAON side. Check the following things:

- Visual observations of LEDs on PT-Link (**Figure 5, page 76**).
- Check baud rate and MAC address.
- Verify protocol selector is MSTP.
- Check AAON device address. Up to four PT-Links can be connected and addressed 1-4.
- Verify wiring
- Verify all AAON devices were discovered in the PT-Link GUI (**page 18**).

Field COM problems

To troubleshoot COM issues in the field, check the following:

- Visual observations of LEDs on PT-Link
- Verify IP address setting
- Verify wiring

NOTE: If the problem still exists, take a Diagnostic Capture and send to AAON Controls Support (**see Figure 4, this page**).

The screenshot displays the fieldserver diagnostic capture interface for a CN1906 Wattmaster MSTP v1.05a device. The interface is divided into a navigation pane on the left and a main content area on the right. The navigation pane shows a tree view with 'CN1906 Wattmaster MSTP v1.05a' expanded, containing sub-items like 'About', 'Setup', 'View', 'User Messages', and 'Diagnostics'. The main content area has tabs for 'Status', 'Settings', and 'Info Stats', with 'Status' selected. Below the tabs is a table with columns 'Name' and 'Value'.

Name	Value
Driver_Configuration	DCC000
DCC_Version	V6.05p (A)
Kernel_Version	V6.51c (D)
Release_Status	Normal
Build_Revision	6.2.2
Build_Date	2022-03-14 04:30:18 -0400
BIOS_Version	4.2.0
FieldServer_Model	FPC-ED2
Serial_Number	2210328013PSH
Carrier Type	SPR Carrier
Data_Points_Used	500
Data_Points_Max	1500
Application Memory:	
Protocol_Engine_Memory_Used	1.19%
Memory_Used	1,902 kB
Memory_Available	158,904 kB
Memory_Free_Bytes	158,904 kB
Memory_Min_Free_Bytes	158,903 kB
Memory_Max_Percent_Used	1.19%
Memory_Max_Bytes_Used	1,902 kB
Memory_Blocks	7662
Avg_Cycle_Time	2
Min_Cycle_Time	2
Max_Cycle_Time	545
Cache_Usage_(RDB)	0

At the bottom of the interface, there are several utility buttons: Home, HELP (?), Contact Us, System Restart, System Reboot, System Time Synch, Reset Cycle Times, and Logout. The fieldserver logo is visible in the bottom right corner.

Figure 4: Diagnostic Capture

LEDs

PT-Link II Board LEDs

The PT-Link is equipped with LEDs that can be used for troubleshooting. There are eight LEDs on the PT-Link board. See **Figure 5, this page**, for the locations of the LEDs on the PT-Link board. The LED descriptions and functions are listed in the following paragraphs.

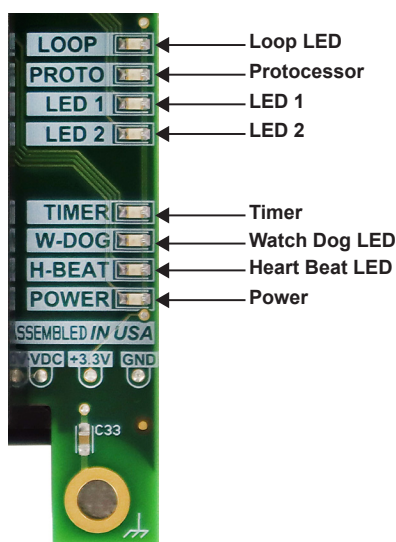

Figure 5: PT-Link LED Locations

POWER LED

When the PT-Link is powered up, the “POWER” LED should light up and stay on continuously. If it does not light up, verify the 24 VAC is connected to the board, that the wiring connections are tight, and they are wired for correct polarity. The 24 VAC power must be connected so all ground wires remain common.

LOOP LED

When power is applied to the PT-Link, the “LOOP” LED also lights up. The LED should flicker rapidly, indicating the PT-Link is trying to communicate with the controllers on the loop. A “flicker” is defined as a brief moment when the LED turns off and back on. If the “LOOP” LED does not operate as indicated above, first power down the unit and then reapply power.

LED 1

When power is first applied, “LED 1” is off temporarily and then blinks one time for each controller it is communicating with. For example, if there are four controllers on the loop connected to the PT-Link, “LED 1” blinks four times. If the amount of blinks does not match the number of controllers connected to the loop, it indicates there is a communications problem. The best way to find out which board is not communicating is to go to each controller and look at its “COMM” LED. The “COMM” LED should be solid and flickers occasionally indicating communication with the PT-Link. If the “COMM” LED does not flicker, there is no communication with that controller.

LED 2

When power is first applied, “LED 2” is off temporarily and then blinks slowly indicating the PT-Link base board is communicating with the ProtoCessor Module. If “LED 2” does not blink, check that the ProtoCessor Module is installed correctly on the PT-Link base board and that the “PWR” LED is lit up on the ProtoCessor Module.

PROTO LED

When the PT-Link is first powered up, the “PROTO” LED should blink rapidly and may appear to be on solid. This LED verifies communication with the board and the ProtoCessor. If the LED doesn’t light up, check that the ProtoCessor is installed correctly and firmly connected to the baseboard. The “PWR” LED should also be lit on the ProtoCessor Module.

TIMER LED

The “TIMER” LED is used for troubleshooting by AAON Controls Support. The “TIMER” LED should always be blinking steadily.

WATCH DOG LED

The “W-DOG” LED is used for troubleshooting by AAON Controls Support. The “W-DOG” LED should always be on solid.

HEARTBEAT LED

The “H-BEAT” LED blinks to show the PT-Link II board software is running.

NOTE: If experiencing problems and the LEDs are not performing normally, contact AAON Controls Support.

LEDs

PT-Link Module LEDs

The PT-Link Module has seven LEDs. See **Figure 6, this page**, for the locations of the LEDs. The LED descriptions and functions are listed in the following paragraphs.

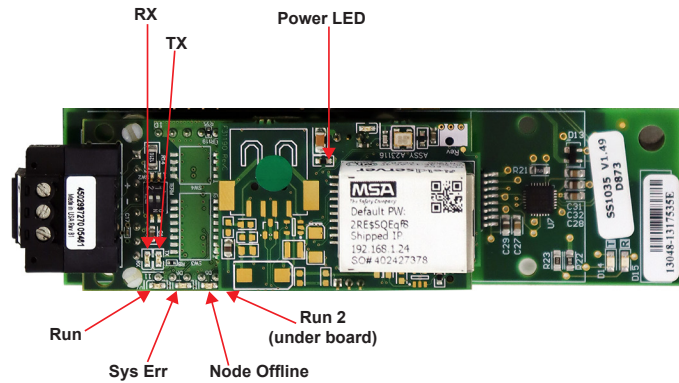

Figure 6: PT-Link LEDs

PWR LED

When the PT-Link is first powered up, the “PWR” green LED should light up and stay on continuously. If the LED does not light up, check that the ProtoCessor is installed correctly and firmly connected to the baseboard.

RX and TX LEDs

During normal operation, the “RX” LED flashes when a message is received on the field port of the ProtoCessor and the “TX” LED flashes when a message is sent on the field port of the ProtoCessor. The “TX” and “RX” LEDs work together to indicate

that communication is being established with the desired protocol network. If both LEDs are blinking, then communication is working properly. If not, check the protocol network wiring and the baud rate in the configuration file.

RUN LED

Upon power up, the “RUN” LED should light up and stay solid for 15 seconds. It should then blink steadily, signifying normal operation. The ProtoCessor should be able to access RUINET once this LED starts flashing.

RUN2 LED

The “RUN2” LED should blink steadily after power up, signifying normal operation. The ProtoCessor should be able to access RUINET once this LED starts flashing.

SYS ERR LED

The “SYS ERR” LED is on solid for 15 seconds after power up and then shuts off. A steady red light indicates there is a system error on the ProtoCessor. If this occurs, immediately report the related “system error” shown in the error screen of the Remote User Interface to FieldServer Technologies for evaluation.

NODE OFFLINE LED

The “NODE OFFLINE” amber LED is on solid for 15 seconds after power up and then shuts off. A steady amber light indicates the ProtoCessor is not communicating with a device that it is polling.

NOTE: If all of these tests are made and the controller still does not operate, please contact AAON Controls Support.

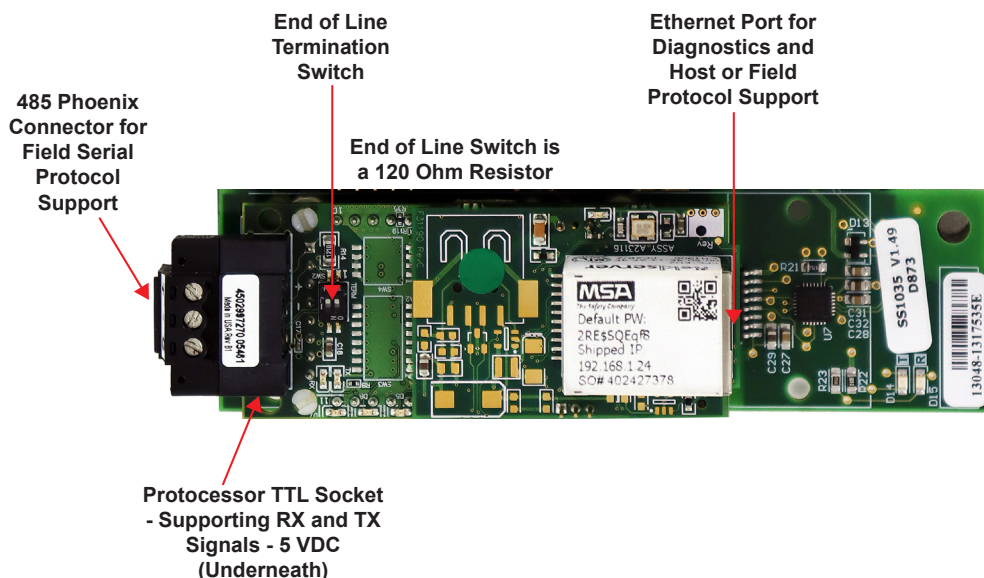

Figure 7: PT-Link Components

PT-Link Connections

Viewing Connections Information

1. Type the IP address of the PT-Link into a web browser to connect to the PT-Link and log in.
2. Click **<Diagnostics and Debugging>** , click **<View>**, then click **<Connections>**.
3. If the **Connections** window shows only zeros, the PT-Link does not have a valid connection. If there are any errors showing in the **Connections** window, please refer to **Connection and Wiring Information, page 8**, for the relevant wiring and settings.

NOTE: The connection S1 - PCP-WMST is working correctly in the example below. The R1 connection is not.

Connections						
Overview						
Connections						
Index	Name	Tx Msg	Rx Msg	Tx Char	Rx Char	Errors
0	S1 - PCP-WMST	355,795	355,794	1,792,567	2,173,846	0
1	R1 - BACnet_MSTP	0	0	0	0	0

Figure 8: Connections Window

ProtoCessor Driver BACnet PICS

BACnet Protocol Implementation Conformance Statement

Date	August 2020
BACnet Vendor Name	MSA Safety
BACnet Vendor ID	37
Product Name	ProtoCessor FFP (FPC-ED2)
Product Description	This software product will provide bi-directional communication between various RTU, DCS, SCADA and PLC using most common protocols and a BACnet system. The FieldServer can perform protocol conversion (as opposed to routing) between the different BACnet Data Link Layer options. This is arranged by way of static mappings.
Protocol Conversions	See MSA Safety's list of protocol drivers to determine available protocol conversions.
BACnet Protocol Version	Version 1 Revision 16

BACnet Standardized Device Profile (Annex L)

X	BACnet Application Specific Controller (B-ASC)
---	--

BACnet Interoperability Building Blocks Supported (Annex K)

X	K.1.1 BIBB - Data Sharing - ReadProperty-A (DS-RP-A)*
X	K.1.2 BIBB - Data Sharing - ReadProperty-B (DS-RP-B)
X	K.1.3 BIBB - Data Sharing - ReadPropertyMultiple-A (DS-RPM-A) *
X	K.1.4 BIBB - Data Sharing - ReadPropertyMultiple-B (DS-RPM-B)
X	K.1.7 BIBB - Data Sharing - WriteProperty-A (DS-WP-A)
X	K.1.8 BIBB - Data Sharing - WriteProperty-B (DS-WP-B)
X	K.1.9 BIBB - Data Sharing - WritePropertyMultiple-A (DS-WPM-A)*
X	K.1.10 BIBB - Data Sharing - WritePropertyMultiple-B (DS-WPM-B)
X	K.1.11 BIBB - Data Sharing - COV-A (DS-COV-A)*
X	K.1.12 BIBB - Data Sharing - COV-B (DS-COV-B)
X	K.2.2 BIBB - Alarm and Event-Notification Internal-B (AE-N-I-B)
X	K.2.5 BIBB - Alarm and Event-ACK-B(AE-ACK-B)
X	K.2.11 BIBB - Alarm and Event-Information-B (AE-INFO-B)
X	K.4.2 BIBB - Trending - Viewing and Modifying Trends Internal-B (T-VMT-I-B)
X	K.4.5 BIBB - Trending - Automated Trend Retrieval-B (T-ATR-B)
X	K.5.1 BIBB - Device Management - Dynamic Device Binding-A (DM-DDB-A)
X	K.5.2 BIBB - Device Management - Dynamic Device Binding-B (DM-DDB-B)
X	K.5.3 BIBB - Device Management - Dynamic Object Binding-A (DM-DOB-A)*
X	K.5.4 BIBB - Device Management - Dynamic Object Binding-B (DM-DOB-B)
X	K.5.6 BIBB - Device Management - DeviceCommunicationControl-B (DM-DCC-B)
X	K.5.12 BIBB - Device Management - TimeSynchronization-B (DM-TS-B)
X	K.5.16 BIBB - Device Management-ReinitializeDevice-B (DM-RD-B)
X	K.5.20 BIBB - Device Management-Restart-B (DM-R-B)
X	K.5.22 BIBB - Device Management - List Manipulation-B (DM-LM-B)
X	K.5.38 BIBB - Network Management-BBMD Configuration-B (NM-BBMD-C-B)

* Client functionality not part of B-ASC profile tested by BTL.

Segmentation Capability

None

ProtoCessor Driver BACnet PICS

Object Types and Optional Properties Supported

Object Type	Optional Properties Supported
Device Object	Location, Description, UTC Offset, Active COV Subscriptions, Database Revision
Analog Input	Reliability, Description
Analog Output	Reliability, Description, Max_Pres_Value, Min_Pres_Value
Analog Value	Reliability, Description
Binary Input	Reliability, Description, Active_Text, Inactive_Text
Binary Output	Reliability, Description, Active_Text, Inactive_Text
Binary Value	Reliability, Description, Active_Text, Inactive_Text
Multi State Input	Reliability, Description, State_Text
Multi State Output	Reliability, Description, State_Text
Multi State Value	Reliability, Description, State_Text
Notification Class Object	
Trend Log	Description, Log_Interval
Life Safety Point	Description

Object Type	Optional Writable Properties
Device Object	Object_Name
Analog Input	Object_Name
Analog Output	Object_Name
Analog Value	Object_Name
Binary Input	Object_Name
Binary Output	Object_Name
Binary Value	Object_Name
Multi State Input	Object_Name
Multi State Output	Object_Name
Multi State Value	Object_Name
Notification Class Object	Object_Name
Life Safety Point	Object_Name
Trend Log	Object_Name

Unsupported Properties and Restrictions

- Does not support BACnet CreateObject
- Does not support BACnet DeleteObject
- Does not support any optional properties
- No additional writeable properties exist
- No proprietary properties exist
- No range restrictions exist
- Client Driver can only read Present Value property

Data Link Layer Options

X	BACnet/IP, (Annex J)
X	ANSI/ATA 878.1, 2.5 Mb, ARCNET (Clause 8)
X	Point-to-Point, EIA 232 (Clause 10), baud rate up to 57.6 Kbps
X	ISO 8802-3, Ethernet (Clause 7)
X	MS/TP master (Clause 9), baud rate up to 76.8 Kbps
X	MS/TP slave (Clause 9), baud rate up to 76.8 Kbps

ProtoCessor Driver BACnet PICS

Device Address Binding

Not supported

Networking Options

	Router, Clause 6 – List all routing configurations, e.g., ARCNET-Ethernet, Ethernet-MS/TP, etc.
	Annex H, BACnet Tunneling Router over IP
X	Annex H.2, Multiple “Virtual” BACnet Devices in a Single Physical Device
X	BACnet/IP Broadcast Management Device (BBMD)
X	Registrations by Foreign Devices

Character Sets Supported

Where support for multiple character sets is indicated, this does not imply that they can all be supported simultaneously.

X	ISO 10646 (UTF-8) ANSI X3.4
	ISO 10646 (UCS-2)
	IBM/Microsoft DBCS
	ISO 10646 (ICS-4)
	ISO 8859-1
	JIS C

Non-BACnet Equipment/Networks Supported

If this product is a communication gateway, describe the types of non-BACnet equipment/network(s) that the gateway supports:

- Modbus RTU
- Modbus TCP/IP
- LonWorks
- Metasys N2
- SNMP
- DNP 3.0 serial and Ethernet
- XML
- GE-EGD
- GE-SRTP
- OPC
- Allen Bradley DF1
- Allen Bradley CSP
- Canatal
- Carrier
- Caterpillar MSX
- DataAire
- EST3 ECP
- EST QuickStart
- Fike Cheetah
- Gamewell-FCI
- GE-SNP
- JBus
- Lutron
- McQuay
- Mircom
- Notifier Fire Panels
- Russelectric
- Secutron
- Siemens Fire Safety
- Silent Knight
- SimplexGrinnell
- Spectronics
- Stulz
- Veeder-Root

PT Link II BACnet5 Technical Guide

Rev. A · 221012

AAON Controls Support:

866-918-1100

Monday through Friday, 7:00 AM to 5:00 PM Central Time

Controls Support website:

www.aaon.com/aaon-controls-technical-support

AAON Factory Technical Support:

918-382-6450 | techsupport@aaon.com

NOTE: Before calling Technical Support, please have the model and serial number of the unit available.

PARTS: For replacement parts, please contact your local AAON Representative.



2425 So. Yukon Ave • Tulsa, OK • 74107-2728

Ph: (918) 583-2266 • Fax: (918) 583-6094

AAON P/N: G114680 , Rev. A

Created in the USA • © October 2022 AAON

All Rights Reserved