

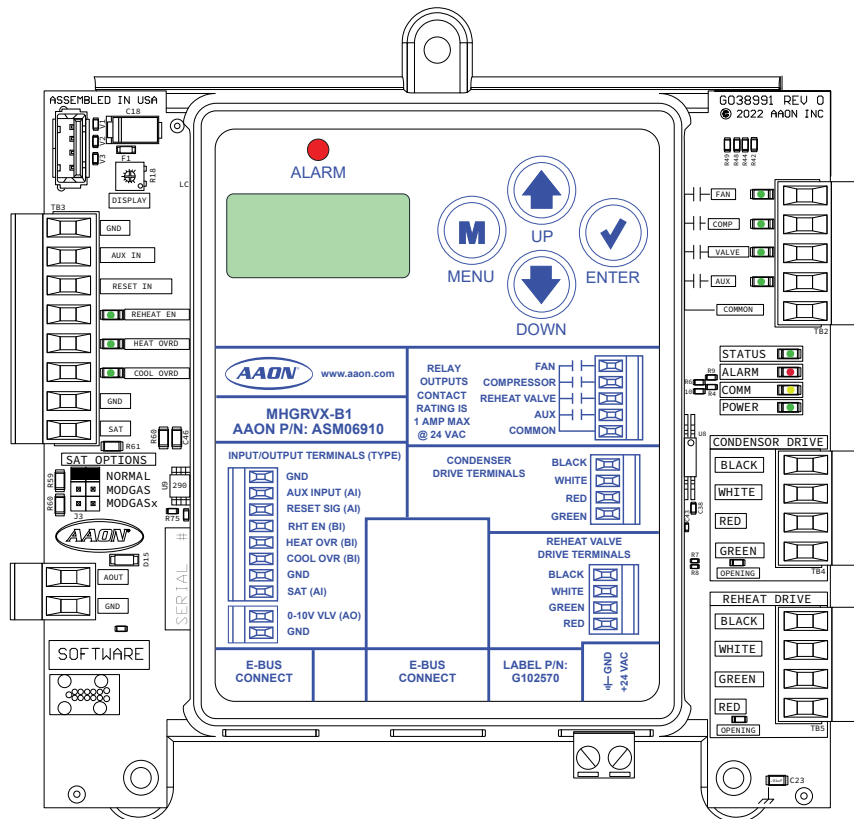

# MHGRVX-B1 Module Field Technical Guide



## MHGRVX-B1 REVISION LOG

REVISION AND DATE	CHANGE
Rev. A, August 5, 2022	Original

## MHGRVX-B1 PARTS REFERENCE

PART DESCRIPTION	PART NUMBER
MHGRV-X	ASM01670
MHGRVX-A1 / MHGRVX-B1 Module (no I <sup>2</sup> C)	ASM07265 / ASM06910
MHGRVX-A2 / MHGRVX-B2 Module (no I <sup>2</sup> C, Sanhua EBV05H valve only)	ASM06926 / ASM06927
MODGAS-X	ASM01668
MODGAS-XWR2	ASM01695
MODGAS-XWR2-B	ASM06909
VCCX2 Controller	ASM01698
AAON Unit Controller	Varies
Supply Air Temperature Sensor	G051240 (6") G051250 (12")
Reheat Expansion Module	ASM01687
E-BUS Cable Assembly E-BUS Power and Comm 1.5 ft., 3 ft., 10 ft., 25 ft., 50 ft., 75 ft., 100 ft., 150 ft., 250 ft., and 1000 ft. spool	G029440 (1.5 ft.), G012870 (3 ft.), G029460 (10 ft.), G045270 (25 ft.), G029510 (50 ft.), G029530 (75 ft.), G029450 (100 ft.), G029470 (150 ft.), V36590 (250 ft.), G018870 (1,000 ft. spool)



[www.aaon.com](http://www.aaon.com)

**This manual is available for download from  
[www.aaon.com/library](http://www.aaon.com/library).**

AAON  
2425 South Yukon Ave.  
Tulsa, OK 74107-2728  
[www.aaon.com](http://www.aaon.com)

Factory Technical Support Phone: 918-382-6450  
AAON Controls Support: 866-918-1100

It is the intent of AAON to provide accurate and current product information. However, in the interest of product improvement, AAON reserves the right to change pricing, specifications, and/or design of its product without notice, obligation, or liability.

AAON P/N: G112880, Rev. A

© August 2022 AAON Inc. All rights reserved throughout the world.

AAON® is a registered trademark of AAON, Inc., Tulsa, OK. AAON assumes no responsibility for errors or omissions in this document.

This document is subject to change without notice.

# TABLE OF CONTENTS

<b>OVERVIEW</b> .....	<b>5</b>
MHGRVX-B1 General Information .....	5
<b>WIRING</b> .....	<b>6</b>
Installation and Wiring.....	6
MHGRVX-B1 to AAON Unit Controller Wiring.....	7
MHGRVX-B1 Stand-Alone Wiring.....	8
<b>INPUTS AND OUTPUTS</b> .....	<b>9</b>
Inputs .....	9
Outputs .....	10
<b>OPERATION MODES</b> .....	<b>11</b>
Modes of Operation .....	11
Additional Features .....	13
<b>LCD SCREENS</b> .....	<b>14</b>
Navigation Keys .....	14
Main Screens Map and Main MHG REHEAT Screens .....	15
Status and Alarm Screens .....	16
Setpoint and Force Valves Screens .....	17
Protected Screens .....	18
<b>TROUBLESHOOTING</b> .....	<b>21</b>
LED Diagnostics .....	21
Alarms .....	22
Other Checks .....	23
<b>APPENDIX A: SAT SENSOR</b> .....	<b>25</b>
Supply Air Temperature Sensor Installation .....	25
SAT Sensor Wiring Guide and Jumper Settings .....	26
<b>APPENDIX B: COMPATIBILITY</b> .....	<b>27</b>
MHGRVX Series Drop-In Replacement.....	27
<b>APPENDIX C: REHEAT EXPANSION MODULE</b> .....	<b>28</b>
Features and Dimensions .....	28
Installation and Wiring.....	29
Wiring.....	30
Operation Modes .....	31
LED Diagnostics and Troubleshooting.....	32
<b>APPENDIX D: FREQUENTLY ASKED QUESTIONS</b> .....	<b>33</b>
Troubleshooting .....	33

## FIGURES

<b>Figure 1:</b> MHGRVX-B1 Dimensions .....	5
<b>Figure 2:</b> MHGRVX-B1 to AAON Unit Controller Wiring .....	7
<b>Figure 3:</b> MHGRVX-B1 Stand-Alone Wiring.....	8
<b>Figure 4:</b> LCD Display and Navigation Keys .....	14
<b>Figure 5:</b> MHGRVX-B1 LED Locations and Descriptions.....	22
<b>Figure 6:</b> Supply Air Temperature Sensor Installation .....	25
<b>Figure 7:</b> Reheat Expansion Module Dimensions .....	27
<b>Figure 8:</b> Reheat Expansion Module(s) Wiring .....	29
<b>Figure 9:</b> Reheat Expansion LED Locations and Descriptions .....	31

## TABLES

<b>Table 1:</b> MHGRVX-B1 Electrical and Environmental Requirements .....	6
<b>Table 2:</b> MHGRVX-B1 Inputs and Outputs .....	9
<b>Table 3:</b> Navigation Key Functions.....	14
<b>Table 4:</b> STATUS LED Blink Codes.....	21
<b>Table 5:</b> ALARM LED Blink Codes.....	21
<b>Table 6:</b> 0-3V Temperature Sensor - Voltage and Resistance for Type III Sensors .....	23
<b>Table 7:</b> 0-5V Temperature Sensor - Voltage and Resistance for Type III Sensors .....	24
<b>Table 8:</b> SAT Wiring Conditions.....	26
<b>Table 9:</b> Reheat Expansion Module ALARM LED Blink Codes.....	31

# OVERVIEW

## MHGRVX-B1 General Information

### Overview

The MHGRVX-B1 is designed to control a Modulating Hot Gas Reheat Valve to maintain a desired Supply Air Temperature Setpoint. The MHGRVX-B1 can be used as a stand-alone module or can be used in conjunction with an AAON unit controller with E-BUS capability.

In addition, up to seven Reheat Expansion Modules can be connected to the MHGRVX-B1 and to each other for additional reheat valve control.

The MHGRVX-B1 connects to an AAON unit controller or expansion module via an E-BUS cable.

**CAUTION:** See Appendix B, page 27, for MHGRVX series compatibility.

**NOTE:** This module does not support I<sup>2</sup>C connections.

### Features

The MHGRVX-B1 provides the following:

- Can be operated as a stand-alone module or communicating with AAON unit controllers.
- Provides for Supply Air Temperature Setpoint reset when required.
- Second stage reheat capability when using two hot gas reheat valves.
- Control of the reheat solenoid valve to provide coil flushing for positive refrigerant oil return.
- Can provide further reheat control using up to seven Reheat Expansion Modules.
- Contains a 2 x 8 LCD character display and four buttons that allow for status display, setpoint changes, and configuration changes

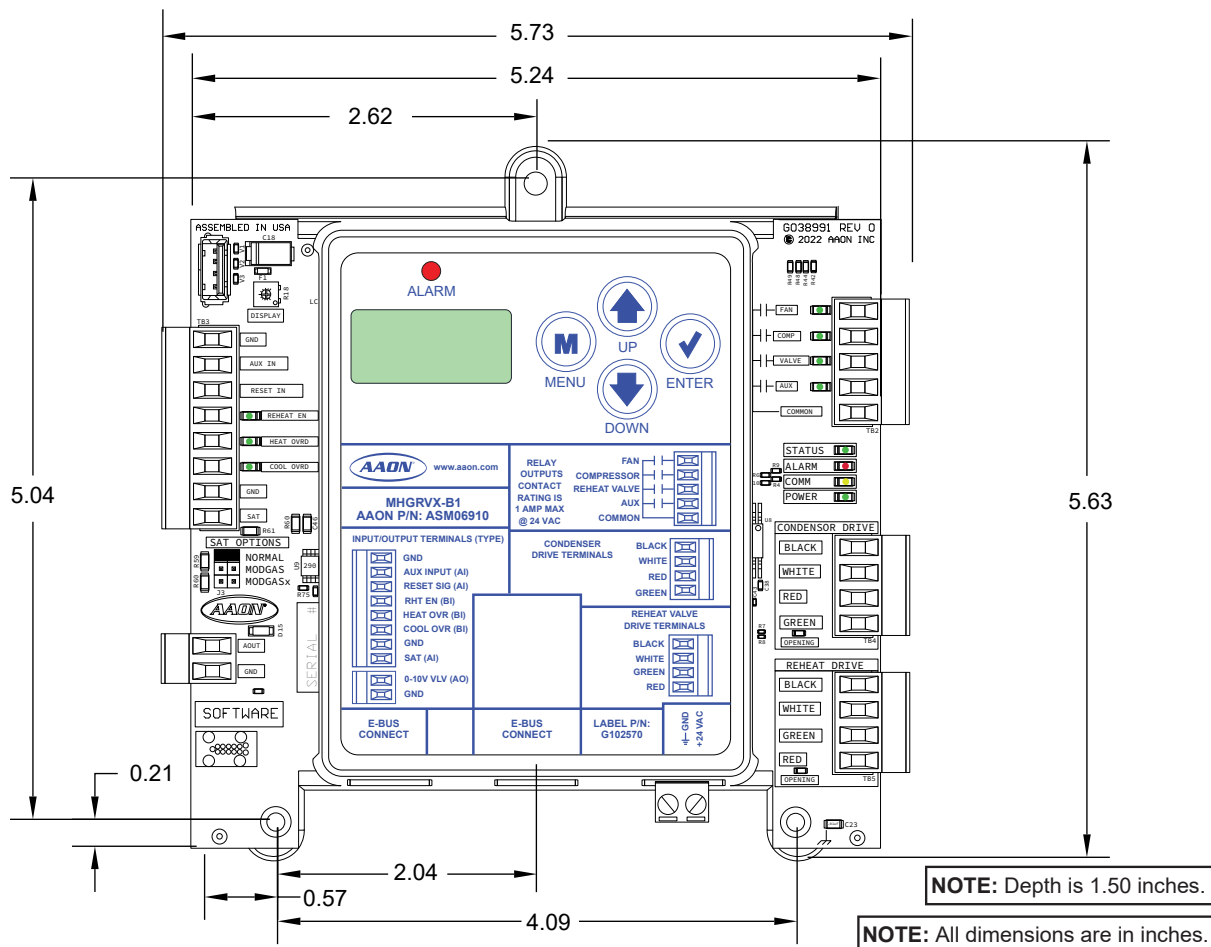

Figure 1: MHGRVX-B1 Dimensions

## Installation and Wiring

### Installation and Mounting

The MHGRVX-B1 is housed in a plastic enclosure. It is designed to be mounted by using the three mounting holes in the enclosure base. It is important to mount the module in a location that is free from extreme high or low temperatures, moisture, dust, and dirt. Be careful not to damage the electronic components when mounting the module.

**NOTE:** The MHGRVX-B1 contains no user-serviceable parts. Contact qualified technical personnel if your controller or module is not operating correctly.

### Wiring

The modules must be connected to an 18-30 VAC power source of the proper size for the calculated VA load requirements. All transformer sizing should be based on the VA ratings listed in **Table 1, this page.**

Control Device	Voltage	VA Load	Operating Temperature	Humidity (Non-Condensing)
MHGRVX-B1	18-30VAC	18	-22°F to 158°F* -30°C to 70°C*	0-95% RH
	Inputs		Resistive Inputs require 10KΩ Type 3 Thermistor	
	Outputs		24VAC Inputs provide 4.7KΩ Load Relay Outputs: 1 Amp maximum per output.	

**Table 1: MHGRVX-B1 Electrical and Environmental Requirements**

**NOTE:** If the temperature at the MHGRVX-B1 is below -4°F (-20°C), the display refresh rate could be less responsive.

**WARNING:** When using a single transformer to power more than one controller, module, or expansion module, the correct polarity must always be maintained between the boards. Failure to observe correct polarity will result in damage to the unit controller, MHGRVX-B1, and any associated modules.

Please carefully read and apply the following information when wiring the unit controller, MHGRVX-B1 and any associated module.

1. All wiring is to be in accordance with local and national electrical codes and specifications.
2. All 24 VAC wiring must be connected so that all ground wires remain common. Failure to follow this procedure can result in damage to the controller and connected devices.
3. Minimum wire size for 24 VAC wiring should be 18-gauge.
4. Minimum wire size for all sensors should be 24-gauge. Some sensors require two-conductor wire and some require three-or four-conductor wire.
5. Minimum wire size for 24 VAC thermostat wiring should be 22-gauge.
6. Be sure that all wiring connections are properly inserted and tightened into the terminal blocks. Do not allow wire strands to stick out and touch adjoining terminals which could potentially cause a short circuit.

**When communication wiring** is to be used to interconnect HVAC unit controllers together or to connect to other communication devices, all wiring must be plenum-rated, minimum 18-gauge, two-conductor, twisted pair with shield. AAON can supply communication wire that meets this specification and is color coded for the network or local loop. Please consult your AAON distributor for information. If desired, Belden #82760 or equivalent wire may also be used.

7. Before applying power to the HVAC unit controller, MHGRVX-B1, and any associated modules, be sure to recheck all wiring connections and terminations thoroughly.

### Powering Up

When the controller and/or modules are first powered up, the POWER LED should light up and stay on continuously. If it does not light up, check to be sure that you have 24 VAC connected to the controller, that the wiring connections are tight, and that they are wired for the correct polarity. The 24 VAC power must be connected so that all ground wires remain common. If after making all these checks, the POWER LED does not light up, please contact AAON Controls Support for assistance.

# WIRING

## MHGRVX-B1 to AAON Unit Controller Wiring

### Communications Wiring

For connection to a VCCX2 or VCB-X Controller, VCCX2 or VCB-X Expansion Module, and Reheat Expansion Module, use an E-BUS cable to connect to the appropriate E-BUS port on those modules and/or controller.

When connected to an AAON unit controller, the Supply Air Temperature Sensor is attached to the AAON unit controller. See **Figure 2, this page.**

See the SAT Wiring Conditions and SAT OPTIONS jumper settings in **Tables 8 and 10, page 26.**

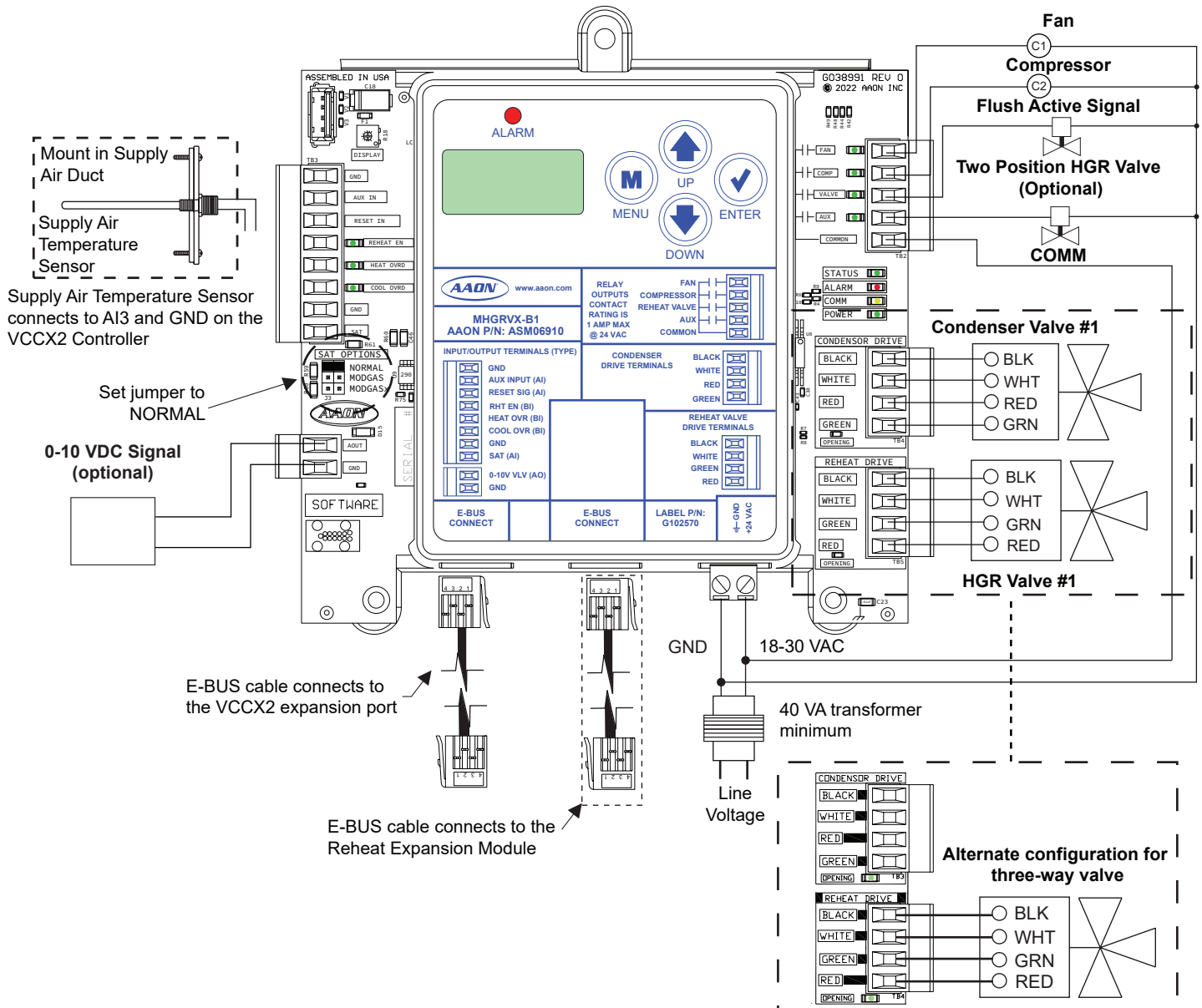

Figure 2: MHGRVX-B1 to AAON Unit Controller Wiring

# WIRING

## MHGRVX-B1 Stand-Alone Wiring

### Stand-Alone Wiring

In Stand-Alone Mode, the MHGRVX-B1 connects to the E-BUS port of the Reheat Expansion Module with an E-BUS cable. See **Figure 3**, this page.

See the SAT Wiring Conditions and SAT OPTIONS Jumper Settings in **Tables 8 and 9**, page 26.

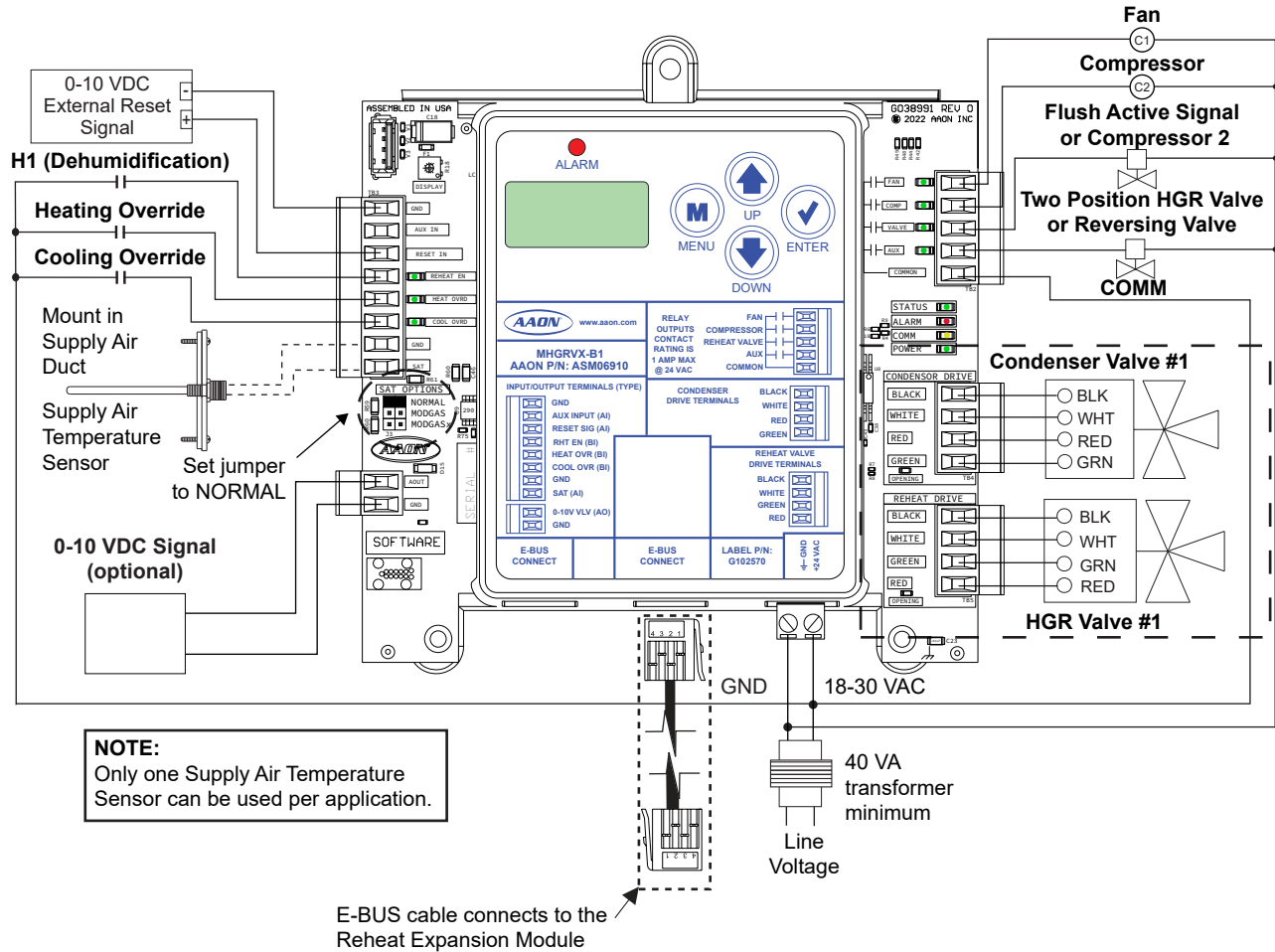

**Figure 3: MHGRVX-B1 Stand-Alone Wiring**



# INPUTS AND OUTPUTS

## Inputs

### I/O Map

The following inputs and outputs are available on the MHGRVX-B1. See **Table 2, this page** to reference the input and outputs.

**NOTE:** All analog and 24 VAC contact closure inputs are used only in Stand-Alone Mode

ANALOG INPUTS	
1	Supply Temperature
2	Reset Signal
3	AUX Input
ANALOG OUTPUTS	
1	0-10 VDC Valve Signal (optional)
BINARY INPUTS	
1	Reheat Enable
2	Heating Override
3	Cooling Override
RELAYS	
1	Fan
2	Compressor
3	Flush Active Signal / Compressor 2
4	Auxiliary / Reversing Valve

**Table 2: MHGRVX-B1 Inputs and Outputs**

### Analog Inputs

#### SAT: Supply Air Temperature Sensor

Used in Stand-Alone Mode and when MODGAS is connected. The Supply Air Temperature Sensor is the main control input. This sensor has to be installed for the unit to operate. The Supply Air Temperature Sensor is located in the discharge air stream and monitors the HVAC unit's Supply Air Temperature to maintain the Supply Air Temperature Setpoint.

#### RST IN: Reset Signal

Used only in Stand-Alone Mode. The Discharge Temperature Setpoint can be reset by supplying a 0-10 VDC signal to the RESET IN low voltage terminal block. This reset signal is optional and need only be used if you require resetting of the discharge air temperature.

#### AUX IN: Auxiliary Reheat Valve Input

Used when AUX mode is configured as enabled. This input looks at a 0-10 VDC signal to control the valve position.

- 0VDC = 0% Reheat Valve position
- 5VDC = 50% Reheat Valve position
- 10VDC = 100% Reheat Valve position.

### Analog Outputs

#### 0-10V VLV: 0-10 VDC Valve Signal

Used when controlling a valve that uses a 0-10 volt signal to drive it.

### Binary Inputs

#### REHEAT EN: Reheat Enable Contact

Used only in Stand-Alone Mode. When a call for dehumidification is initiated by another controller, this interlocked 24 VAC wet contact closure is used to enable the MHGRVX-B1.

#### HEAT OVR: Heating Override

Used only in Stand-Alone Mode. When a call for heating is initiated by the HVAC unit, this interlocked 24 VAC wet contact closure is used to override the MHGRVX-B1 Dehumidification Mode.

#### COOL OVR: Cooling Override

Used only in Stand-Alone Mode. When a call for cooling is initiated by the HVAC unit, this interlocked 24 VAC wet contact closure is used to override the MHGRVX-B1 Dehumidification Mode.

## Outputs

### Relay Outputs

#### **FAN: Fan Enable**

When a call for Dehumidification, Cooling Override, or Heating Override is received, this relay will be closed to energize the HVAC unit Supply Fan.

#### **CMP: Compressor Enable**

When a call for Dehumidification or Cooling Override is received, this relay will be closed to energize the Compressor(s).

#### **VALVE: Flush Active Signal / Compressor 2**

If configured as Flush, this relay will be active any time a Flush Cycle is active. When the Flush Cycle ends this relay will turn off until the next flush occurs.

If configured as Compressor 2, this relay will be used to control a second Compressor when there is a call for Dehumidification. Compressor 2 will come on 30 seconds after the first Compressor activates. Compressor 2 has a minimum run time of 10 minutes, and will turn off if the Reheat Valve is at 100% and the Supply Air Temperature is 5°F below setpoint for one minute. After being off for 10 minutes, it can come back on if the Supply Air Temperature is 5°F above setpoint and the valve is at 0%.

#### **AUX: Two-Position HGR Valve / Reversing Valve**

If configured as standard, this relay will be used to control a two-position HGR valve. Used on larger capacity systems that have an optional two-position HGR Valve in addition to the Modulating HGR Valve. When a call for Dehumidification is received, if the modulating HGR valve is at 100% and the Supply Air Temperature is at least 5°F below setpoint, this relay output will energize to enable the two-position HGR valve. The relay will de-energize when the modulating HGR valve closes to 0% and the Supply Air Temperature is at least 5°F above setpoint.

The modulating valve is then enabled to modulate to maintain the Supply Air Temperature Setpoint.

If configured as Reversing Valve, this relay will control a Reversing Valve on a Heat Pump unit. Any time there is a call for Cooling or Dehumidification, this relay will be energized.

#### **COM: Relay Common**

Requires 24 VAC from transformer.

# OPERATION MODES

## Modes of Operation

### Initialization

The MHGRVX-B1 uses on-board LEDs to indicate various diagnostic conditions during power-up and operation. It also uses an LCD display to show initialization. Please review this information for a complete description of the initialization sequence.

### Modulating Hot Gas Valves

The MHGRVX-B1 utilizes two modulating valves to control the flow of Hot Gas through the Hot Gas Reheat Coil. One of these valves is the Condenser Hot Gas Valve and the other is the Hot Gas Reheat Valve. The valves are wired to the MHGRVX-B1 Modulating Hot Gas Valve Output terminals. These valves work in concert with each other to create a “three-way valve” configuration. As one closes, the other opens, etc. All modes of operation that follow referring to the Hot Gas Reheat Valve are actually a combination of these two valves working together to achieve the specified sequence of operation.

---

**NOTE:** Some units use a three-way valve instead of two separate valves. The three way valve is wired to the Reheat terminal block.

---

## Modes of Operation

The MHGRVX-B1 can be used in two different modes of operation. These modes behave in a similar manner; the main difference is the way they receive information to control the dehumidification process.

### Stand-Alone Mode

As the name implies, in this mode the module behaves as an independent unit. The module begins the dehumidification process when the Dehumidification Input “H1” receives a 24 VAC signal from an outside source. When the signal is received, the module will activate the “FAN” output to energize the HVAC unit fan. At the same time, the module will initiate Cooling Mode by energizing the “CMP” output starting the HVAC unit compressor. At this time, the MHGRVX-B1 will start to modulate the Modulating Hot Gas Reheat Valve. The module will modulate the MHGR valve to maintain the Supply Air Temperature Setpoint by activating the stepper motor outputs on the MHGR Valve.

The Supply Air Setpoint is configured with the Setpoint Screen in the LCD display. If Supply Air Temperature Reset is used, it will initiate when a 0-10 VDC signal is supplied to the “RESET IN” input. As the voltage increases from 0 to 10 volts at the “RESET IN” input, the Supply Air Temperature will be reset towards the Supply Air Reset Temperature Setpoint. This setpoint is configured with the Setpoint Screen in the LCD display. When a 10-volt input signal is received at the “RESET IN” input, it will be controlling at the Supply Air Temperature Reset Setpoint. The controller will conclude the Dehumidification process when input “H1” is deactivated, the input “Cool Override” is activated, or the input “Heat Override” is activated.

### Auxiliary Mode Stand-Alone

1. Auxiliary Mode Operation needs to be configured first from the display.
2. This mode will be activated if the Reheat Enable input is enabled. Any expansion boards that are enabled will follow.
3. Reheat Valve
  - The unit will keep the valve off for the first 30 seconds
  - Then it will modulate the valve between 0% to 100% to match the 0-10 VDC Auxiliary Analog input.
4. The unit will exit Reheat Mode when the reheat input is disabled. The expansion modules will do the same.
5. Relay Operation
  - Fan Relay will be activated in this mode.
  - Compressor Relay will be activated in this mode.
  - Auxiliary Relay
    - It will be activated if the Reheat Valve stays at 100% for two minutes and the Supply Air Temperature is 5°F below the Supply Air Setpoint.
    - It will deactivate if the Reheat Valve stays at 0% for two minutes and the Supply Air Temperature is 5°F above the Supply Air Setpoint.

## Modes of Operation

---

### Communications Operation

In this mode, the MHGRVX-B1 behaves as an expansion board for an AAON unit controller. The controller begins the dehumidification process when the AAON unit controller makes a request to the MHGRVX-B1 for dehumidification. At that time, the controller will activate the “FAN” output to energize the HVAC unit fan. At the same time, the controller will initiate Cooling Mode by energizing the “CMP” output starting the HVAC unit compressor.

At this time, the MHGRVX-B1 will start to modulate the Modulating Hot Gas Reheat Valve. The controller will modulate the MHGR valve to maintain the Supply Air Temperature Setpoint by activating the stepper motor outputs on the MHGR valve. The Supply Air Setpoint is set by programming the HVAC unit controller. If Supply Air Temperature Reset is used, it will initiate when the HVAC unit controller ends a request to reset the Supply Air Temperature.

The Supply Air Temperature will be reset towards the Supply Air Reset Temperature Setpoint stored in the HVAC unit controller. It will send a request to move towards the Supply Air Temperature Reset Setpoint based on its setpoints and configuration.

The controller will conclude the Dehumidification process when the HVAC unit controller sends a request to terminate Dehumidification or a Cooling or Heating Override request is made by the HVAC unit controller. Any setpoints or signals at the inputs to the MHGRVX-B1 will be ignored.

### Auxiliary Mode Communicating

1. Same as the Stand-Alone Auxiliary Mode, but the Reheat Enable and Auxiliary Valve position will be sent using E-BUS commands.

## Additional Features

---

### Additional Features

---

#### Reheat Coil Flush

To assure positive oil return to the compressor, the Hot Gas Reheat Coil will be flushed of liquid refrigerant by moving the Modulating Gas Reheat Valve to its maximum position for a short interval.

#### Cooling Flush

If the unit is in Cooling Mode, a flush will occur when the unit's flush cooling interval timer has elapsed. The time is accumulated whenever it is in cooling mode and resets after each flush cycle. The flush cooling interval timer is a setpoint that is configurable using the keypad and display (0 to 120 minutes in 10 minute increments).

#### Reheat Mode Flush

If the unit is in Dehumidification Mode and the valve is below 70% for the flush reheat interval timer value, a flush will occur. If the valve goes above 70%, the timer is reset. The flush reheat interval timer is a setpoint that is configurable using the keypad and display (0 to 120 minutes in 10 minute increments).

#### Condenser Coil Flush

If Condenser Coil Flush is configured and the unit is in Dehumidification Mode and the reheat valve is above 70% for the flush reheat interval timer value, a condenser flush will occur. This shares the timer with the reheat flush so if the valve is below 70% a Reheat Flush would occur.

#### Optional Second Stage Reheat

On larger systems, where more hot gas reheat capacity may be required, a two-position Hot Gas Reheat Valve can be connected to the MHGRVX-B1 to be used in conjunction with the Modulating Hot Gas Reheat Valve. Any time the reheat demand moves above the Modulating Hot Gas Reheat Valve capacity, this two-position valve would be energized to supply additional hot gas to the Hot Gas Reheat Coil. As the reheat demand is satisfied, the MHGRVX-B1 will de-energize the two-position valve and control reheat with the Modulating Hot Gas Reheat Valve.



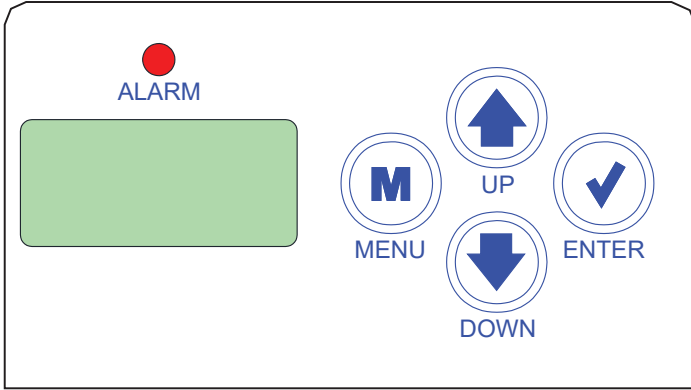

## Navigation Keys

### LCD Display Screen and Navigation Keys

The LCD display screens and buttons allow you to view status and alarms, and enable force modes. See **Figure 4, this page** and refer to **Table 3, this page** for descriptions.



**Figure 4: LCD Display and Navigation Keys**

NAVIGATION KEY	KEY FUNCTION
<b>MENU</b> 	Use the MENU key to move through screens within Main Menu categories and return to the Main Menu while at other screens.
<b>UP</b> 	Use this key to adjust setpoints and change configurations.
<b>DOWN</b> 	Use this key to adjust setpoints and change configurations.
<b>ENTER</b> 	Use the ENTER key to navigate through the Main Menu Screen categories.

**Table 3: Navigation Key Functions**

# LCD SCREENS

## Main Screens Map and Main MHG REHEAT Screens

### Main Screens Map

Refer to the following map when navigating through the LCD Main Screens. The first screen is an initialization screen. To scroll through the rest of the screens, press the **<MENU>** button.

MHGRVX  
3001vXXX

Press  to scroll through the main screens.

Press  to go to STATUS Screens.

STATUS  
MENU

Press  to scroll through STATUS Screens.

Press  to go to ALARMS Screens.

ALARMS  
MENU

Press  to scroll through ALARMS Screens.

Press  to go to SETPOINTS Screens.

SETPOINT  
MENU

Press  to scroll through SETPOINT Screens.

Press  to go to FORCE VALVE Screens.

FORCE  
MENU

Press  to scroll through FORCE VALVES Screens.

### Main Screens

Refer to the following map when navigating through the Main Screens. From the main screen, press **<ENTER>** to scroll through the screens.

MHGRVX  
3001vXXX



S/A MODE,  
SA MODE LOCKED  
OR COMM MODE

In Stand-Alone Mode, the screen will display S/A MODE or S/A MODE LOCKED.

In Communications Mode, the screen will display COMM MODE and the items below will scroll through the screen:

1. Number of good packets being received. This will roll over after 9999. Example: +XXXX
2. Number of checksum errors. This will stop at 9999. Example: C-XXXX
3. Number of packet length errors. This will stop at 9999 until power is cycled. Example: P-XXXX



SOFTWARE  
3001vXXX

CURRENT SOFTWARE VERSION



ADDRESS  
1 (132)

CURRENT BOARD ADDRESS



# LCD SCREENS

## Status and Alarm Screens

### Status Screens

Refer to the following map when navigating through the Status Screens. From the STATUS Screen, press <ENTER> to scroll through the screens.



Status Screens shown below will scroll automatically if LCD display is left on this screen for 20 seconds.



#### MODE

This screen displays the current mode of operation of the MHGRVX-B1. The mode options are:

**OFF:** This mode will display if the unit is not in Dehumidification Mode and there is no call for Modulating Hot Gas Reheat (MHGR).

**REHEAT:** During Dehumidification, the unit will enter the Reheat Mode and will begin to modulate the MHGR Valve to maintain the Supply Air Temperature Setpoint. The unit will leave the Reheat Mode when the unit leaves the Dehumidification Mode.

**FLUSH:** This mode will display if the unit is performing a cooling flush cycle or a reheat flush cycle (see Additional Features, [page 13](#)).

**AUX:** If Aux operation has been enabled, a 0-10 VDC signal can be used to proportionally modulate the MHGR Valve between 0 – 100 %.

**FORCE!:** The unit is in the Force Mode.

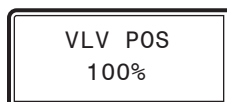

#### VALVE POSITION

0 to 100 percent



#### SUPPLY AIR TEMPERATURE

40°F to 150°F or 5°C to 65°C.

If no sensor is detected, screen will display "NO SENSR"

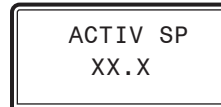

#### ACTIVE SUPPLY AIR SETPOINT

Calculated from SAT setpoint and reset signal. Displays INACTIVE when in OFF Mode or not needing to be calculated.

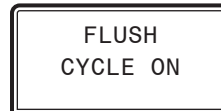
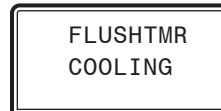

#### FLUSH TIMER AND FLUSH STATUS

Flush Timer screen will display if the unit is in Cooling Flush Mode, Reheat Flush Mode, or Disabled. It will then display the time remaining in minutes until the Flush Cycle begins. If the unit is in the Flush Cycle, it will display FLUSH CYCLE ON.

### Alarm Screens

Refer to the following map when viewing Alarm Screens. These screens will display automatically when alarms are present. For more information, see [pages 21 and 22](#).



The alarms are as follows:

**NO ALARMS:** This will be shown if there are no current alarms.

**SAT FAIL ERROR:** The Supply Air Temperature sensor has been disconnected for more than 60 seconds. This alarm will be disabled when the sensor is reconnected.

**COMM T/O ERROR:** Communications have been lost with the AAON unit controller. This alarm will disable when communications resume.



# LCD SCREENS

## Setpoint and Force Valves Screens

### Setpoint Screens

Refer to the following map when navigating through the Setpoint Screens. From the SETPOINT Screen, press **<ENTER>** to scroll through the screens and change setpoints. Use the **<UP>** and **<DOWN>** arrow keys to change your selections. Then press **<ENTER>** to save the new setpoint.

**WARNING:** When the MHGRVX-B1 is operating in Communications Mode (connected to the AAON unit controller), these Setpoint Screens will not appear on the LCD display because they are controlled by the AAON unit controller. To access these setpoints, temporarily disconnect the MHGRVX-B1 from the AAON unit controller.

SETPOINT



SAT SP  
40 - 150°F

#### REHEAT SUPPLY AIR TEMPERATURE SETPOINT

This is the target temperature while reheat is enabled. If you are using the reset signal, this is the setpoint it will calculate to at zero volts. Will display only in Stand-Alone Mode. The SAT Setpoint is set by the LCD display in Stand-Alone Mode and is set by the AAON unit controller in Communications Mode.

Minimum	Default	Maximum
40°F 5°C	70°F 21°C	150°F 65°C



RESET SP  
40 - 150°F

#### RESET REHEAT SUPPLY AIR SETPOINT

This is maximum temperature at which the Supply Air Temperature will reset to. Will display only in Stand-Alone Mode. The Reset SAT Setpoint is set by the LCD Display in Stand-Alone Mode and is set by the AAON unit controller in communicating mode.

Minimum	Default	Maximum
40°F 5°C	70°F 21°C	150°F 65°C

### Force Valves Screens

Refer to the following map when navigating through the Force Screens. From the FORCE VALVES screen, press **<ENTER>**. At the FORCE MODE screen, press the **<UP>** arrow key to turn the FORCE MODE on and press the **<DOWN>** arrow key to turn the FORCE MODE off.

**NOTE:** When you turn the Force Mode off or after one hour has elapsed, the valves will reinitialize to zero.

FORCE  
MENU



FORCE  
MODE ON/OFF

Press the **<UP>** button to turn the Force Mode on. Press the **<DOWN>** button to turn the Force Mode off.



FRC VALV  
X%

#### FORCE VALVE PERCENTAGE

This screen only appears when Force Mode is on.

Press the **<UP>** button to increase the percentage. Press the **<DOWN>** button to decrease the percentage.



FRC EXP  
X%

#### FORCE EXPANSION VALVE PERCENTAGE

This screen only appears when Force Mode is on and Expansion Valves are Enabled.

Press the **<UP>** button to increase the percentage. Press the **<DOWN>** button to decrease the percentage.



FORCE  
TIMEOUT

#### FORCE MODE TIME OUT

This screen will appear when the Force Mode times out after one hour.

## Protected Screens

### Protected Screens Map

Refer to the following map when navigating through the LCD Protected Screens. From the main screen, press the **<ENTER>** twice until you get to the SOFTWARE Screen. Then hold the **<UP>** button for five seconds. To scroll through the rest of the screens, press the **<MENU>** button.

MHGRVX  
3001vXXX



S/A MODE,  
SA MODE LOCKED  
OR COMM MODE



SOFTWARE  
3001vXXX

Hold  for five seconds.

CONFIG



DIAGNSTC



ENTER TO  
EXIT



## Protected Screens

### Configuration Screens

Refer to the following map when navigating through the Configuration Screens. From the CONFIG Screen, press **<ENTER>** to scroll through the screens and change setpoints. Use the **<UP>** and **<DOWN>** arrow keys to change your selections. Press **<ENTER>** to save any changes.



#### CURRENT ADDRESS OF THE BOARD.

The address is only used in Communications Mode. Default is 1.



#### AUXILIARY MODE ENABLE

If enabled, auxiliary input controls the position of the valve.



#### AUXILIARY RELAY

Standard or Reversing Valve



#### VALVE STEPS

Valve size: 3193 or 6386

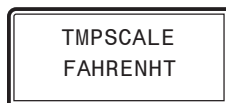

#### TEMPERATURE SCALE

Fahrenheit (default) or Celsius

This setting is only used in Stand-Alone Mode.

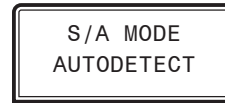

#### S/A MODE FORCED

S/A Mode Autodetect (default) or Locked.  
Forces the module to be Stand-Alone Mode only.



#### REHEAT EXPANSION MODULE VALVES

Expansion Valves Disabled (default) or Enabled.  
If Expansion Valves are enabled, the screen below will appear.

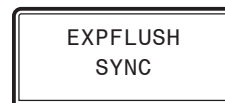

#### EXPANSION VALVES FLUSH

Expansion Valves flush independently or together. This screen is only available if the Expansion Valves are enabled.



#### COOLING FLUSH CYCLE TIME

0-120 minutes or disabled.

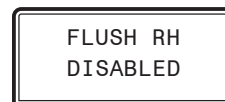

#### REHEAT FLUSH CYCLE TIME

0-120 minutes or disabled.

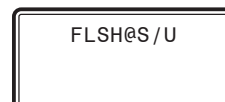

#### FLUSH AT STARTUP

Flush at startup, disabled or enabled.



## Protected Screens

VALV RLY

### VALVE RELAY

FLUSH, COMP 2, or REHEAT  
Configures how the VALVE relay operates.



VLV MAX  
100

### VALVE MAX

Used to configure the Max Reheat Valve %.



FLSH CND  
DISABLED

### FLUSH CONDENSER

Used to enable or disable condenser flushes.

## Diagnostic Screens

Refer to the following map when navigating through the Diagnostic Screens. From the DIAGNSTC Screen, press **<ENTER>** to scroll through the screens.

DIAGNSTC



WDOG CNT  
#

### WATCH DOG TIMER

Displays the number of times the board has been reset due to watchdog timer overflow.



PWER CNT  
#

### POWER LOSS COUNT

Displays the number of times the board has been reset due to power loss.



STEP CNT  
XXXX

### STEP COUNT

Shows the step count status the valve is currently at.

# TROUBLESHOOTING

## LED Diagnostics

### General

The MHGRVX-B1 is equipped with LEDs that can be used to verify operation and perform troubleshooting. There are LEDs for communication, operation modes, and diagnostic codes. The module has 14 LEDs—12 used for operation and status, and two used for alarms.

See **Figure 5, page 22** for the LED locations. The LEDs associated with these inputs and outputs allow you to see what is active without using a voltmeter. The LEDs and their uses are as follows:

### Operation LEDs

**POWER** - This green LED will light up to indicate that 24 VAC power has been applied to the module. If it does not light up, check to be sure that the power wiring is connected to the board, the connections are tight, and the transformer is powered. If after making all these checks, the POWER LED does not light up, the board is probably defective.

**STATUS** - At power up the Status light blinks three quick blinks five times with a pause after the third blink. Then, the CONDENSER VALVE DRIVE LED starts blinking as the condenser valve is sent to 100% and reheat valve is sent to 0%. After this, the STATUS LED blinks according to what mode the module is in. See **Table 4, this page**.

No. of Blinks	STATUS LED
1	Off Mode
2	Reheat Mode
3	Flush Mode
4	Force Mode
5	SAT Sensor Failure Mode

**Table 4: STATUS LED Blink Codes**

### Diagnostic LEDs

**ALARM (on board)** - This red LED will light up to indicate an alarm. The type of alarm will display on the LCD display. See **Table 5, this page**.

**ALARM (above LCD display)** - The LED blinks when an alarm is active.

No. of Blinks	ALARM LED
1	Supply Air Temperature Sensor Failure
2	Communications Time Out Error

**Table 5: ALARM LED Blink Codes**

### Communication LED

**COMM** - This yellow LED will light up and blink when communications are detected.

### Relay LEDs

**FAN** - This green LED will light up to indicate that the relay for the “FAN” output is energized and its Normally Open Contact is closed.

**COMP** - This green LED will light up to indicate that the relay for the “COMP” output is energized and its Normally Open Contact is closed.

**VALVE** - This green LED will light up to indicate that the relay for the “VALVE” output is energized and its Normally Open Contact is closed.

**AUX** - This green LED will light up to indicate that the relay for the “AUX” output is energized and its Normally Open Contact is closed.

### Binary Input LEDs

**REHEAT ENABLE** - This green LED will light up when the Reheat is enabled.

**HEAT OVERRIDE** - This green LED will light up when Heat Override is enabled.

**COOL OVERRIDE** - This green LED will light up when Cool Override is enabled.

### Analog Output LEDs

**CONDENSER VALVE DRIVE** - This LED blinks any time the condenser valve is opening and reheat valve is closing.

**REHEAT VALVE DRIVE** - This LED blinks any time the reheat valve is opening and the condenser valve is closing.

# TROUBLESHOOTING

## Alarms

### Supply Air Temperature Failure

- Verify that the Supply Air Temperature Sensor is connected to the SAT and GND on the MHGRVX-B1 or MODGAS module (Stand-Alone Mode) or to AI2 and GND on the AAON unit controller (communicating mode).
- Remove SAT and GND wiring from MHGRVX-B1 and ohm sensor out (this may indicate open or failed wiring). Refer to chart in back of this guide for readings.
- Verify the SAT OPTIONS jumper settings on the MHGRVX-B1 for the Supply Air Temperature Sensor.

### Communications Loss

- Check COMM LED on MHGRVX-B1.
- Verify 24 VAC power to all interconnected AAON unit controllers.
- Verify E-BUS connection between the MHGRVX-B1 and associated AAON unit controllers.
- In communication mode (connected to an AAON unit controller with modular cable), confirm that module's MHGRVX-B1 status screen displays Position % and that main screens show COMM MODE.

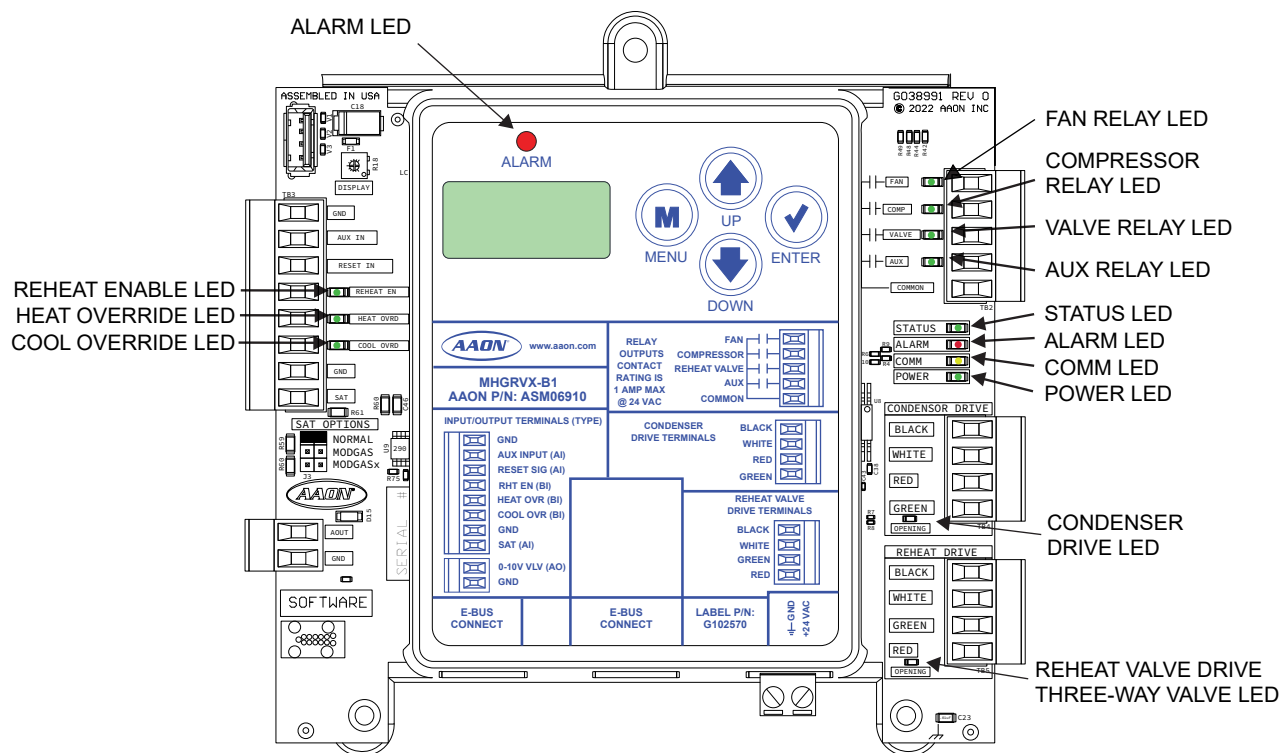

Figure 5: MHGRVX-B1 LED Locations and Descriptions

# TROUBLESHOOTING

## Other Checks

### Supply Air Temperature Sensor

If you suspect the Supply Air Temperature Sensor is not reading correctly, make sure the wiring terminal connections are tight and that any wiring splices are properly connected. You can check the operation of the Supply Air Temperature Sensor by measuring the resistance or voltage using a digital multimeter.

#### Measuring Voltage

Set the meter to DC Volts. Place the positive probe on the AIN terminal and the negative probe on the GND terminal. Read the DC Volts and find that voltage in **Table 6, this page** and **Table 7, page 24**. Read the temperature corresponding with that voltage and determine if this is close to the actual temperature the sensor is exposed to. If the temperature from the chart is different by more than a few degrees, you probably have a defective or damaged sensor.

### Thermistor Sensor Testing Instructions

1. Use the resistance column to check the thermistor sensor while disconnected from the controllers (not powered).
2. Use the voltage column to check sensors while connected to powered controllers. Read voltage with meter set on DC volts. Place the “-” (minus) lead on GND terminal and the “+” (plus) lead on the sensor input terminal being investigated.

#### Measuring Resistance

To read the resistance, set the meter to Ohms. Unplug the sensor connector from the board and measure the resistance across the disconnected wires. This resistance should match the corresponding temperature from **Table 6, this page**, and **Table 7, page 24**.

**TEMPERATURE TO RESISTANCE/VOLTAGE CHART**

Temp (°F)	Temp (°C)	Resistance (Ohms)	Voltage @ Input (VDC)	Temp (°F)	Temp (°C)	Resistance (Ohms)	Voltage @ Input (VDC)
-10	-23.3	93333	2.98	72	22.2	11136	1.74
-5	-20.6	80531	2.94	73	22.8	10878	1.72
0	-17.8	69822	2.89	74	23.3	10625	1.70
5	-15	60552	2.83	75	23.9	10398	1.68
10	-12.2	52500	2.77	76	24.4	10158	1.66
15	-9.4	45902	2.71	78	25.6	9711	1.63
20	-6.6	40147	2.64	80	26.7	9302	1.59
25	-3.9	35165	2.57	82	27.8	8893	1.55
30	-1.1	30805	2.49	84	28.9	8514	1.52
35	1.7	27140	2.41	86	30	8153	1.48
40	4.4	23874	2.33	88	31.1	7805	1.45
45	7.2	21094	2.24	90	32.2	7472	1.41
50	10	18655	2.15	95	35	6716	1.33
52	11.1	17799	2.11	100	37.8	6047	1.24
54	12.2	16956	2.08	105	40.6	5453	1.16
56	13.3	16164	2.04	110	43.3	4923	1.09
58	14.4	15385	2.00	115	46.1	4449	1.02
60	15.6	14681	1.96	120	48.9	4030	.95
62	16.7	14014	1.93	125	51.7	3656	.88
64	17.8	13382	1.89	130	54.4	3317	.82
66	18.9	12758	1.85	135	57.2	3015	.76
68	20	12191	1.81	140	60	2743	.71
69	20.6	11906	1.79	145	62.7	2502	.66
70	21.1	11652	1.78	150	65.6	2288	.61
71	21.7	11379	1.76				

**Note:** If the voltage is above 3.3 VDC the sensor or wiring is “open.” If the voltage is less than 0.05 VDC, the sensor or wiring is shorted.

**Table 6: 0-3V Temperature Sensor - Voltage and Resistance for Type III Sensors**

# TROUBLESHOOTING

## Other Checks

### Thermistor Sensor Testing Instructions

1. Use the resistance column to check the thermistor sensor while disconnected from the controllers (not powered).
2. Use the voltage column to check sensors while connected to powered controllers. Read voltage with meter set on DC volts. Place the “-” (minus) lead on GND terminal and the “+” (plus) lead on the sensor input terminal being investigated.

### Measuring Resistance

To read the resistance, set the meter to Ohms. Unplug the sensor connector from the board and measure the resistance across the disconnected wires. This resistance should match the corresponding temperature from **Table 6, page 23**, and **Table 7, this page**.

**TEMPERATURE TO RESISTANCE/VOLTAGE CHART**

Temp (°F)	Temp (°C)	Resistance (Ohms)	Voltage @ Input (VDC)	Temp (°F)	Temp (°C)	Resistance (Ohms)	Voltage @ Input (VDC)
-10	-23.3	93333	4.620	72	22.2	11136	2.695
-5	-20.6	80531	4.550	73	22.8	10878	2.665
0	-17.8	69822	4.474	74	23.3	10625	2.635
5	-15	60552	4.390	75	23.9	10398	2.607
10	-12.2	52500	4.297	76	24.4	10158	2.577
15	-9.4	45902	4.200	78	25.6	9711	2.520
20	-6.6	40147	4.095	80	26.7	9302	2.465
25	-3.9	35165	3.982	82	27.8	8893	2.407
30	-1.1	30805	3.862	84	28.9	8514	2.352
35	1.7	27140	3.737	86	30	8153	2.297
40	4.4	23874	3.605	88	31.1	7805	2.242
45	7.2	21094	3.470	90	32.2	7472	2.187
50	10	18655	3.330	95	35	6716	2.055
52	11.1	17799	3.275	100	37.8	6047	1.927
54	12.2	16956	3.217	105	40.6	5453	1.805
56	13.3	16164	3.160	110	43.3	4923	1.687
58	14.4	15385	3.100	115	46.1	4449	1.575
60	15.6	14681	3.042	120	48.9	4030	1.469
62	16.7	14014	2.985	125	51.7	3656	1.369
64	17.8	13382	2.927	130	54.4	3317	1.274
66	18.9	12758	2.867	135	57.2	3015	1.185
68	20	12191	2.810	140	60	2743	1.101
69	20.6	11906	2.780	145	62.7	2502	1.024
70	21.1	11652	2.752	150	65.6	2288	0.952
71	21.7	11379	2.722				

**Note:** If the voltage is above 5.08 VDC the sensor or wiring is “open.” If the voltage is less than 0.05 VDC, the sensor or wiring is shorted.

**Table 7: 0-5V Temperature Sensor - Voltage and Resistance for Type III Sensors**



# APPENDIX A: SAT SENSOR

## Supply Air Temperature Sensor Installation

### Mounting the Supply Air Temperature Sensor

The Supply Air Temperature Sensor should be located in the ductwork downstream of the unit supply air connection. Locate the sensor in the center of the widest part of the duct. Use the supplied template and a 5/16 inch drill to make a hole for the sensor. Install the gasket over the probe and mount securely to the duct using the supplied sheet metal screws. Be sure the gasket is compressed to provide an air tight seal. To help prevent thermal gradients from affecting the sensor, apply insulation on the outside of the duct, over the sensor.

**WARNING:** Make sure your Supply Air Temperature Sensor is mounted and wired according to these instructions prior to testing the unit or else the modulating valve will not control properly and may damage your equipment.

### Stand-Alone Mode

In Stand-Alone Mode, the SAT Sensor is connected to the MHGRVX-B1. If, in Stand-Alone Mode, the MHGRVX-B1 is used in conjunction with a Stand-Alone MODGAS-X, the SAT sensor is shared between the two controllers and always attaches to the MODGAS-X.

See **Figure 3, page 8** for wiring.

### Communication Mode

When communicating with AAON unit controllers, the SAT Sensor will be connected to the AAON unit controller.

See **Figure 2, page 7**, for wiring.

Leads are non-polarized. Butt splice leads to 24-gauge wire minimum.

In Stand-Alone and in retrofit applications, connect leads to "SAT" and "GND" on the module.

If using a VCCX2 controller, connect leads to "AI3" and "GND" on main controller.

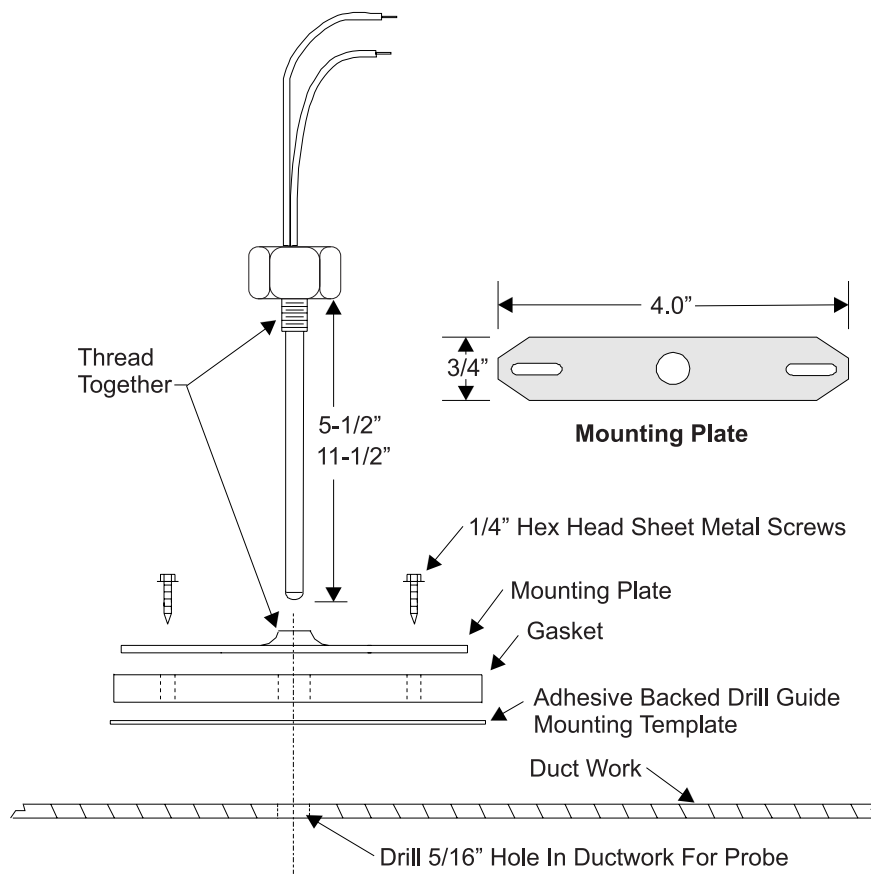

Figure 6: Supply Air Temperature Sensor Installation

# APPENDIX A: SAT SENSOR

## SAT Sensor Wiring Guide and Jumper Settings

### SAT Wiring Conditions

**NOTE:** The MHGRVX-B1 does not support I<sup>2</sup>C connections.

### SAT OPTIONS Jumper Settings

See **Table 8, this page**, for SAT wiring conditions. See **Figures 2 and 3 on pages 7 and 8** for jumper locations.

	MODGAS-X ONLY	MHGRVX-B1 ONLY	MODGAS-X AND MHGRVX-B1
<b>Stand-Alone</b>	Install Supply Air Sensor in MODGAS-X.	Install Supply Air Sensor in MHGRVX-B1. Set "SAT Options" Jumpers to "Normal".	Install Sensor in MODGAS-X and daisy-chain it to the MHGRVX-B1. Set "SAT Options" Jumpers to "MODGAS X".
<b>VCCX2 VCB-X</b>	Install Supply Air Sensor in VCCX2 or VCB-X. Connect to VCCX2 or VCB-X using E-BUS cable.	Install Supply Air Sensor in VCCX2 or VCB-X. Connect to VCCX2 or VCB-X using E-BUS cable.	Install Supply Air Sensor in VCCX2 or VCB-X. Connect to VCCX2 or VCB-X using E-BUS cable.

**Table 8: SAT Wiring Conditions**

## APPENDIX B: COMPATIBILITY

### MHGRVX Series Drop-In Replacement

	I <sup>2</sup> C Communication	Valve Dependant	Compatibility	Other
MHGRV-X	Yes	No	MHGRV II, MHGRVX-A1*, MHGRVX-B1*	
MHGRVX-A1	No	No	MHGRV-X*, MHGRVX-B1*	
MHGRVX-A2	No	Sanhua EBV05H only	MHGRVX-B2	
MHGRVX-B1	No	No	MHGRV-X*, MHGRVX-A1*	Additional AOUT input on board
MHGRVX-B2	No	Sanhua EBV05H only	MHGRVX-A2	Additional AOUT input on board

\*These modules do not support I<sup>2</sup>C communication.

**Table 9: MHGRVX Series Modules Compatibility**

# APPENDIX C: REHEAT EXPANSION MODULE

## Features and Dimensions

### Overview

The ASM01687 Reheat Expansion Module is designed to control one set of reheat valves.

The Reheat Expansion Module connects to the MHGRVX-B1 via an E-BUS cable.

Connected together, the Reheat Expansion Modules provide a system that allows the proper control of multiple sets of valves.

**NOTE:** The Reheat Expansion Module has two possible configurations with slightly different dimensions. Both configurations are interchangeable but may require adjustment of the snap tracks.

See **Figure 8, this page** for dimensions.

**NOTE:** The Reheat Expansion Module software must be at least 1.07 to function correctly with the MHGRVX-B1 module.

### Features

The Reheat Expansion Module provides the following:

- Up to seven Reheat Expansion Modules can be used
- Each Reheat Expansion Module controls one set of reheat valves (one Reheat and one Condenser)
- Each Reheat Expansion Module has its own cooling reheat flush timers
- Reheat Expansion Modules conveniently plug into one another

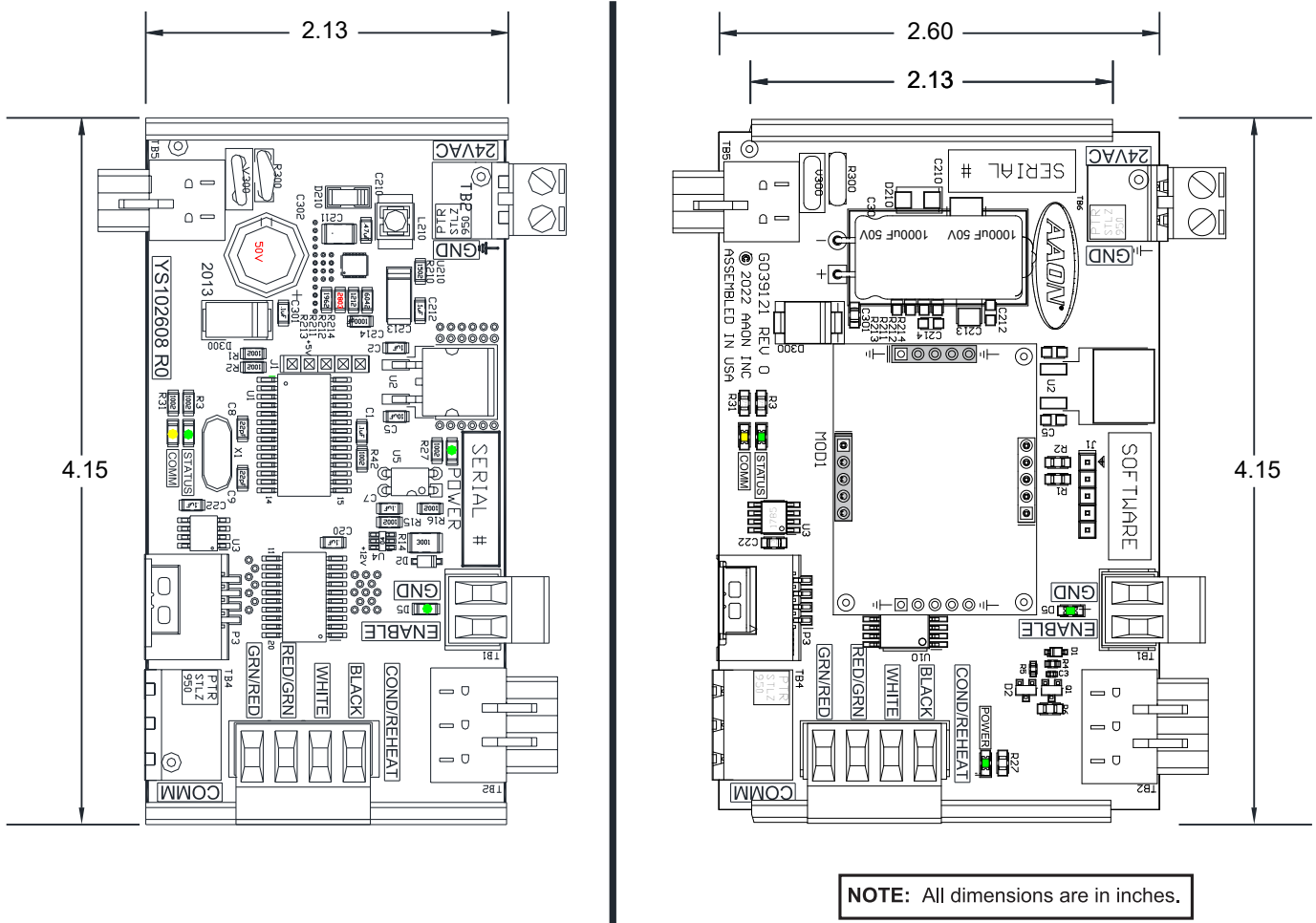

Figure 7: Reheat Expansion Module Dimensions

## Installation and Wiring

### Installation and Mounting

The Reheat Expansion Module is provided with a Chevron cut plastic snap track mounting base. The snap track is designed to be mounted using a ¼" Hex Head Sheet Metal Screw (provided) to a flat surface using the pre-punched mounting hole that is provided in the center of the snap track. The Reheat Expansion Module is then snapped into place on the snap track, providing for easy field mounting and servicing.

The Reheat Expansion Module needs to be installed in an environment which can maintain a temperature range between -22°F and 158°F not to exceed 95% RH levels (non-condensing). It is important to keep the module in a location that is free from extreme high or low temperatures, moisture, dust, and dirt. Be careful not to damage the electronic components.

---

---

**NOTE:** The Reheat Expansion Module contains no user-serviceable parts. Contact qualified technical personnel if your controller or module is not operating correctly.

---

---

### General Wiring Information

For the wiring diagram to use when the MHGRVX-B1 is connected to an AAON unit controller, see **Figure 2, page 7**. For the Stand-Alone wiring diagram, see **Figure 3, page 8**.

For Reheat Expansion Board wiring, see **Figure 8, page 30**.

Please carefully read and apply the following information when wiring the Reheat Expansion Module(s):

1. 18-gauge minimum wire unless otherwise noted.
2. 24 VAC power connection with an appropriate VA rating.
3. Compressor Enable must have 24-gauge minimum wire.
4. All 24 VAC wiring must be connected so that all ground wires remain common. Failure to follow this procedure can result in damage to the module and connected devices.
5. All wiring is to be in accordance with local and national electrical codes and specifications.
6. Check all wiring leads at the terminal block for tightness. Be sure that wire strands do not stick out and touch adjacent terminals. Confirm that all transducers required for your system are mounted in the appropriate location and wired into the correct terminals.



## Operation Modes

---

### Initialization

---

The Reheat Expansion Module uses on-board LEDs to indicate various diagnostic conditions during power-up and operation. See the LED Operation section on [page 32](#) for more information.

### Modulating Hot Gas Valves

---

Each Reheat Expansion Module utilizes two modulating valves to control the flow of Hot Gas through the Hot Gas Reheat Coil. One of these valves is the Condenser Hot Gas Valve and the other is the Hot Gas Reheat Valve. The valves are wired to the Reheat Expansion Module's Modulating Hot Gas Valve Output terminals. These valves work in concert with each other to create a "three-way valve" configuration. As one closes, the other opens, etc. All modes of operation that follow referring to the Hot Gas Reheat Valve are actually a combination of these two valves working together to achieve the specified sequence of operation.

### Mode of Operation

---

The Reheat Expansion Module(s) can be used in MHGRVX-B1 Stand-Alone Mode and when the MHGRVX-B1 is communicating to an AAON unit controller.

#### Stand-Alone Mode

See [page 11](#) for MHGRVX-B1 Stand-Alone Mode. Once the Reheat Expansion Module's Binary Input Compressor input is enabled, the valve positions follow the MHGRVX-B1.

#### Operation in Communicating Mode

In this mode, the MHGRVX-B1 behaves as an expansion board for an AAON unit controller. See [page 12](#) for detailed operation. Once the Reheat Expansion Module's Binary Input Compressor input is enabled, the valve positions follow the MHGRVX-B1.

### Additional Features

---

#### Reheat Coil Flush

To assure positive oil return to the compressor, the Hot Gas Reheat Coil will be flushed of liquid refrigerant by moving the Modulating Gas Reheat Valve to its maximum position for a short interval.

#### Cooling Flush

If the unit is in cooling mode, a flush will occur when the unit's flush cooling interval timer has elapsed. The time is accumulated whenever it is in cooling mode and resets after each flush cycle. The flush cooling interval timer is a setpoint that is configurable using the keypad and display (0 to 120 minutes in 10 minute increments). If enabled, each Reheat Expansion Module follows the same sequence as the MHGRVX-B1, using the same cooling flush interval timer of the MHGRVX-B1. The expansion boards do not flush at the same time.

#### Reheat Mode Flush

If the unit is in dehumidification mode and the valve is below 70% for the flush reheat interval timer value, a flush will occur. If the valve goes above 70%, the timer is reset. The flush reheat interval timer is a setpoint that is configurable using the keypad and display (0 to 120 minutes in 10 minute increments). If enabled, each Reheat Expansion Module follows the same sequence as the MHGRVX-B1, using the same flush reheat interval timer of the MHGRVX-B1. The expansion boards do not flush at the same time.

#### Optional Flush Mode Configurations

A configuration option is available that will provide a 30 second flush cycle whenever the unit enters the cooling, dehumidification, and heat pump modes. If using Reheat Expansion Module(s) in conjunction with the MHGRVX-B1, a configuration option is available to force all the valves to flush synchronously instead of independently.

Contact AAON Controls Support for assistance in making these configuration changes.

# APPENDIX C: REHEAT EXPANSION MODULE

## LED Diagnostics and Troubleshooting

### LED Diagnostics

The Reheat Expansion Module is equipped with four LEDs that can be used to verify operation and perform troubleshooting.

See **Figure 10, this page** for the LED locations. The LEDs associated with these inputs and outputs allow you to see what is active without using a voltmeter. The LEDs and their uses are as follows:

#### Operation LEDs

- **POWER:** This green LED will light up to indicate that 24 VAC power has been applied to the Expansion Module.
- **STATUS:** This green LED will light up and blink every 10 seconds according to valve position. One blink per 10%. Example: valve position is 67%. STATUS LED will blink six times every 10 second cycle. The STATUS LED will stay on solid during the two-minute flush cycle. See **Table 9, this page**.

No. of Blinks	STATUS LED
1-10	Per 10% valve position
Solid	During two-minute flush cycle

**Table 10: Reheat Expansion Module ALARM LED Blink Codes**

### Communication LED

- **COMM:** This amber LED will light up and blink once for every good packet received. Packets should be sent once every second, so the COMM LED should blink the same, once every second. The COMM LED should blink simultaneously on all modules.

### Binary Input LED

- **COMPRESSOR ENABLE:** This green LED will light up when the Reheat is enabled.

### LED Troubleshooting

- **“POWER” LED:** When the Reheat Expansion Module is powered up, the POWER LED should light up and stay on continuously. If it does not light up, check to be sure that the power wiring is connected to the board, the connections are tight, and the transformer is powered. If after making all these checks, the POWER LED does not light up, the board is probably defective.
- **“STAT” LED:** When the board is first powered up, the STAT LED will do the following:
  - On for 10 seconds
  - Blinks 30 times
  - Status code repeatedly blinks the indicated valve position every ten seconds

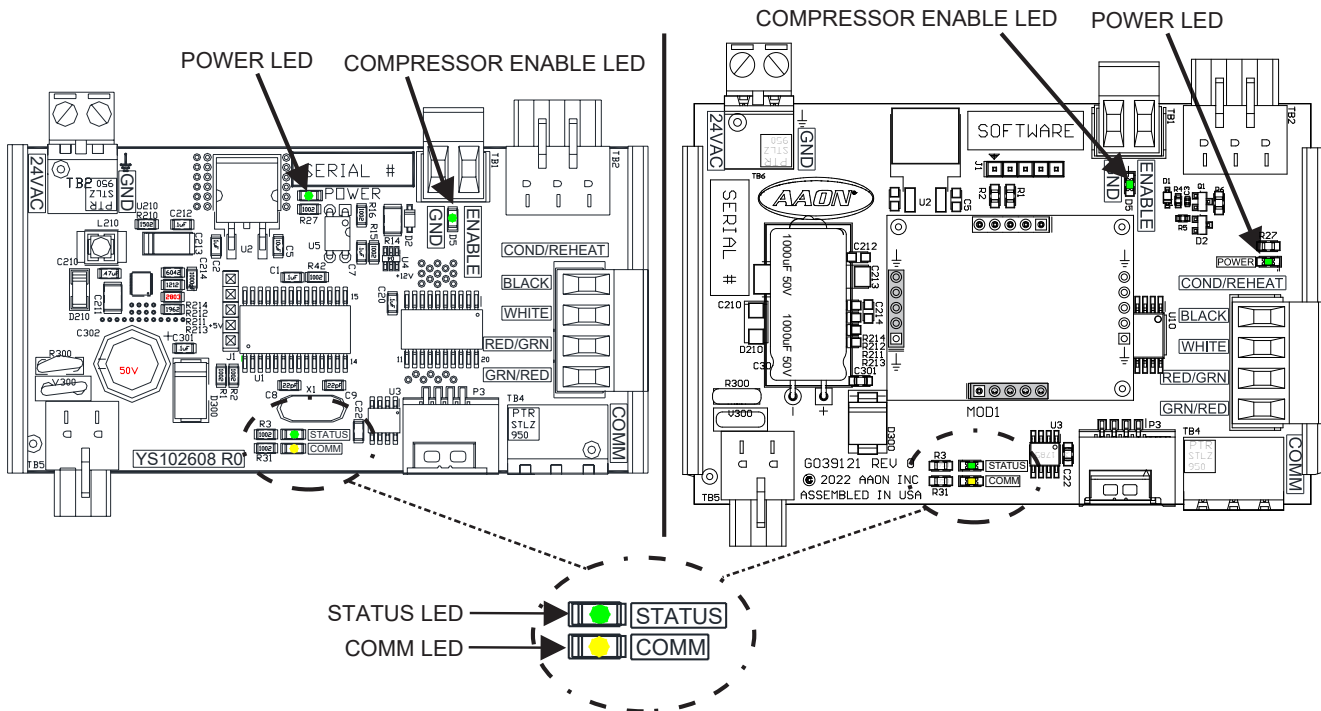

**Figure 9: Reheat Expansion LED Locations and Descriptions**



## Troubleshooting

### Frequently Asked Questions

The following are common questions and their answers:

**Q: Can the MHGRVX-B1 be used as a replacement for an existing MHGRV-X?**

**A:** It is not intended to be used as a drop-in replacement for any MHGRV-X or MHGRV II modules.

**Q: Which controllers and modules can be used with the MHGRVX-B1**

**A:** VCCX2 or VCB-X Controller, VCCX2 or VCB-X Expansion Module, and Reheat Expansion Module.

**Q: Is there power to the expansion module?**

**A:** The POWER LED should be lit at all times. If not, check the 24 VAC input voltage. If the input voltage is confirmed and the POWER LED is not lit, the board is physically damaged.

**Q: Is the expansion module communicating?**

**A:** You should always see the COMM LED(s) blinking simultaneously on all modules. The communication chain is physically connected from board to board; however, the communications circuit is a parallel connection so it is possible one module could be inoperable while others down the chain are operating.

**A:** If you see the COMM LED on solid, then the module has not detected communications for over 60 seconds.

**Q: Is the valve position correct?**

**A:** The STATUS LED on the Reheat Expansion Board will blink the valve position every 10 seconds if the valve is not closed. It will blink the position divided by 10. So, for example, if the position is 68%, the STATUS LED will blink six times.

**A:** The valve position displayed on the MHGRVX-B1 Status Screen should match the expansion module's valve position. The expansion module must have the enable signal activated for the valve position to mirror the MHGRVX-B1.

**Q: The STATUS LED is on solid. What does this mean?**

**A:** The expansion module is performing its own flush cycle. Each expansion module tracks its own flush cycles. The flush time setpoints are always the same as the MHGRVX-B1 setpoints.

**Q: I have no communications. Can my valve still drive?**

**A:** If communication is lost, the valve will drive closed.

**Q: How can I test if the expansion module will drive the valve?**

**A:** From the MHGRVX-B1, you can go to the Force Menu and manually drive the expansion module valves open and closed.

**Q: Are my valves wired correctly?**

**A:** Both valves per circuit should be wired to the same terminal block.

**A:** The Condenser Valve should be wired (from top to bottom) BLACK, WHITE, RED, GREEN.

**A:** The Reheat Valve should be wired (from top to bottom) BLACK, WHITE, GREEN, RED.

**Q: How do I confirm the expansion module is operating in Reheat (Dehumidification) mode?**

**A:** Make sure the enable signal is activated by confirming that the ENABLE LED is on.

**A:** Make sure the COMM LED is blinking.

**A:** Compare the Valve Position displayed on the MHGRVX-B1 screen with the number of STATUS LED blinks.

**A:** If all three things above are true, then the valve is operating correctly in Reheat mode.

### Troubleshooting

---

**Q: Are the communications wired and configured correctly?**

**A: For the MHGRVX-B1 operating as Stand-Alone, the following should be true:**

1. The MHGRVX-B1 is connected to the Reheat Expansion Module with an E-BUS cable and the connections are secure.
2. The MHGRVX-B1 must be configured as S/A LOCKED in the MHGRVX-B1 Configuration Screens. To confirm this, press the ENTER key once from the main screen. It should display S/A MODE LOCKED.
3. The MHGRVX-B1 must be configured for EXP VLVS ENABLED in the MHGRVX-B1 Configuration Screens. If this is true, the COMM LED on the MHGRVX-B1 will blink once every second.

**A: For the MHGRVX-B1 operating with a VCCX2/VCB-X, the following should be true:**

1. The VCCX2 or VCB-X, MHGRVX-B1, and Reheat Expansion Module are connected to each other with an E-BUS cable and the connections are secure.
2. The MHGRVX-B1 must be configured as S/A AUTODECT in the MHGRVX-B1 Configuration Screens. To confirm this, press the ENTER key once from the main screen. It should display COMM MODE.
3. The MHGRVX-B1 must be configured for EXP VLVS ENABLED in the MHGRVX-B1 Configuration Screens. If this is true, the COMM LED on the MHGRVX-B1 will blink once every second.

**Q: How do I change configurations for the valve expansion modules?**

**A: Configurations will always match how the MHGRVX-B1 is configured. The configurations are as follows:**

1. Valve Size (hidden screen configuration)
2. Cooling Flush Time (setpoint screens when Stand-Alone)
3. Reheat Flush Time (setpoint screens when Stand-Alone)
4. Reheat Flush Reset Position (cannot be changed by user)

**MHGRVX-B1 Technical Guide**  
**G112880 · Rev. A · 220805**

**AAON Controls Support:**

866-918-1100

Monday through Friday, 7:00 AM to 5:00 PM Central Time

**Controls Support website:**

[www.aaon.com/aaon-controls-technical-support](http://www.aaon.com/aaon-controls-technical-support)

**AAON Factory Technical Support:**

918-382-6450 | [techsupport@aaon.com](mailto:techsupport@aaon.com)

**NOTE:** Before calling Technical Support, please have the model and serial number of the unit available.

**PARTS:** For replacement parts, please contact your local AAON Representative.



2425 South Yukon Ave • Tulsa, OK • 74107-2728  
Ph: (918) 583-2266 • Fax: (918) 583-6094  
AAON P/N: **G112880**, Rev. A

Printed in the USA • Copyright August 2022 • All Rights Reserved