

# Systems Design Technical Guide

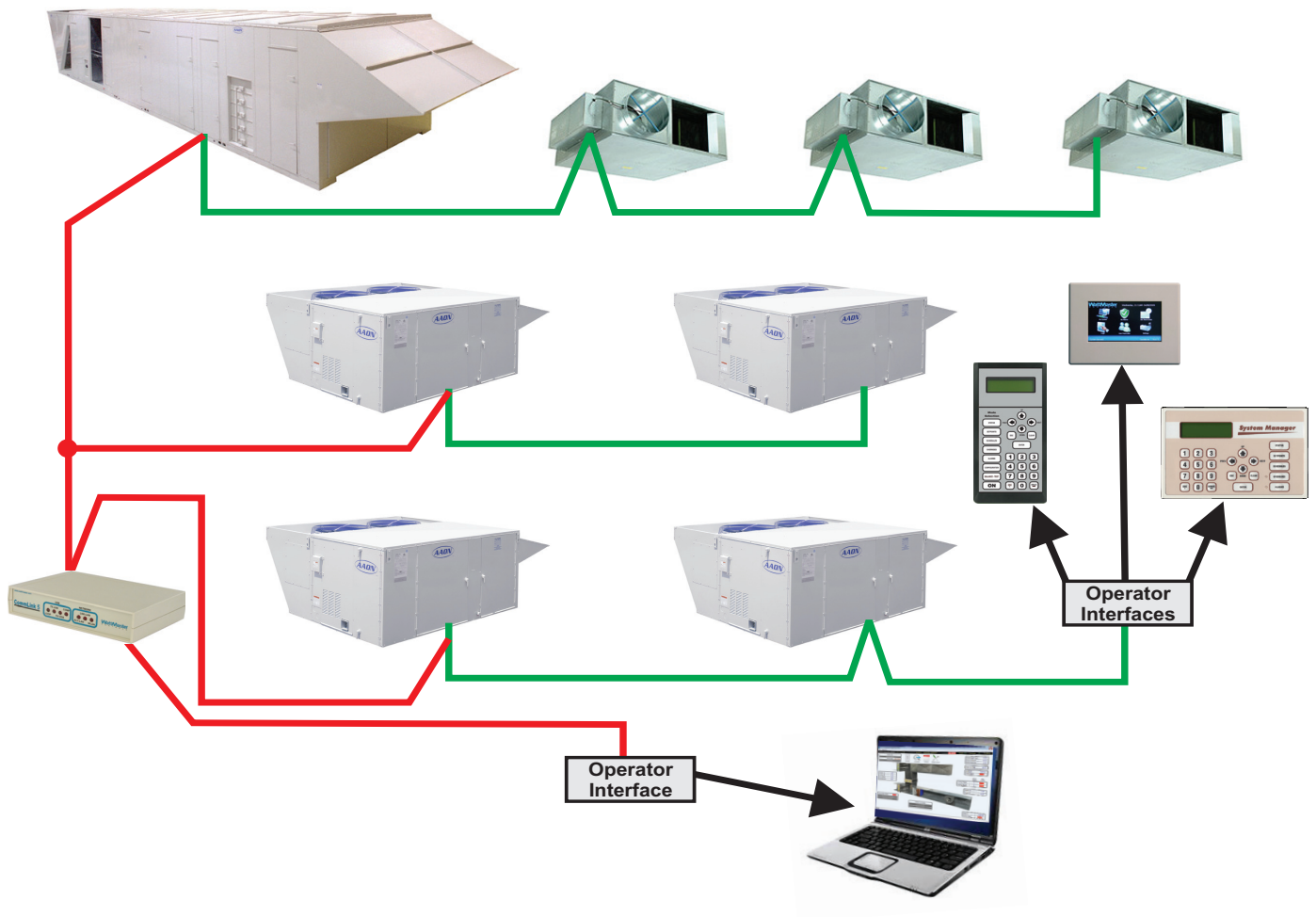

# TABLE OF CONTENTS

<b>OVERVIEW.....</b>	<b>3</b>
Selecting the Right Orion System .....	3
System Selection Chart .....	3
<b>STAND ALONE SYSTEM .....</b>	<b>4</b>
Operator Interface Options .....	4
Communication Device Options.....	5
Add-On Controller Requirements.....	5
<b>INTERCONNECTED SYSTEM.....</b>	<b>6</b>
Operator Interface Options .....	6
Communication Device Options.....	7
Add-On Controller Requirements.....	7
<b>NETWORKED SINGLE LOOP SYSTEM.....</b>	<b>8</b>
HVAC Unit Controllers .....	8
HVAC Unit Controller with VAV/Zone Controllers.....	8
Operator Interface Options .....	8
Communication Device Options.....	11
Add-On Controller Requirements.....	11
<b>NETWORK MULTIPLE LOOP SYSTEM.....</b>	<b>12</b>
HVAC Unit Controllers .....	12
HVAC Unit Controller with VAV/Zone Controllers.....	12
Operators Interface Options.....	13
Communication Device Options.....	15
Add-On Controller Requirements.....	15
<b>STAND ALONE SYSTEM WIRING .....</b>	<b>16</b>
<b>INTERCONNECTED SYSTEM WIRING.....</b>	<b>17</b>
<b>NETWORK SINGLE LOOP SYSTEM WIRING .....</b>	<b>18</b>
<b>NETWORK MULTIPLE LOOP SYSTEM WIRING .....</b>	<b>21</b>
<b>COMMUNICATION CONNECTIONS AND WIRING .....</b>	<b>22</b>
CommLink 5 and IP Module Wiring.....	22
USB-Link 2 Wiring.....	23
MiniLink Polling Device 5 Wiring.....	24
<b>APPENDIX .....</b>	<b>25</b>

WattMaster Controls, Inc.  
8500 NW River Park Drive · Parkville, MO 64152  
Toll Free Phone: 866-918-1100  
PH: (816) 505-1100 · FAX: (816) 505-1101 · E-mail: mail@wattmaster.com  
Visit our web site at www.orioncontrols.com  
Form: OR-SYS-TGD-01D Copyright November 2017 WattMaster Controls, Inc.  
AAON® is a registered trademark of AAON, Inc., Tulsa, OK.  
Windows® 2000, Vista, 7, 8 & 10 are registered trademarks of Microsoft Corporation.  
WattMaster Controls, Inc. assumes no responsibility for errors, or omissions.  
This document is subject to change without notice.

**Selecting the Right Orion System**

**System Selection**

Orion Controllers can be connected together with communication wiring and devices to form complete systems solutions. Orion Controllers can be configured into four main system types. The right system for you depends on the number and type of controllers being used. Each of these main system types have a series of options available that relate to what kind of operator interface(s) you wish to use to configure and monitor your Orion system. Several other options are available depending on the system type and operator interface you have selected. By selecting the right system and options, you can build a complete HVAC controls system that will meet your job requirements.

**Using the Selection Chart**

WattMaster has designed this publication in order to make it easy to select the right Orion system type for your specific application. Start by selecting a main system type from the selection chart below. Proceed to the pages listed on the selection chart for information and available options for that system type. After deciding what operator interface and other options you want, proceed to the connections & wiring section pages listed for that system type for detailed installation information.

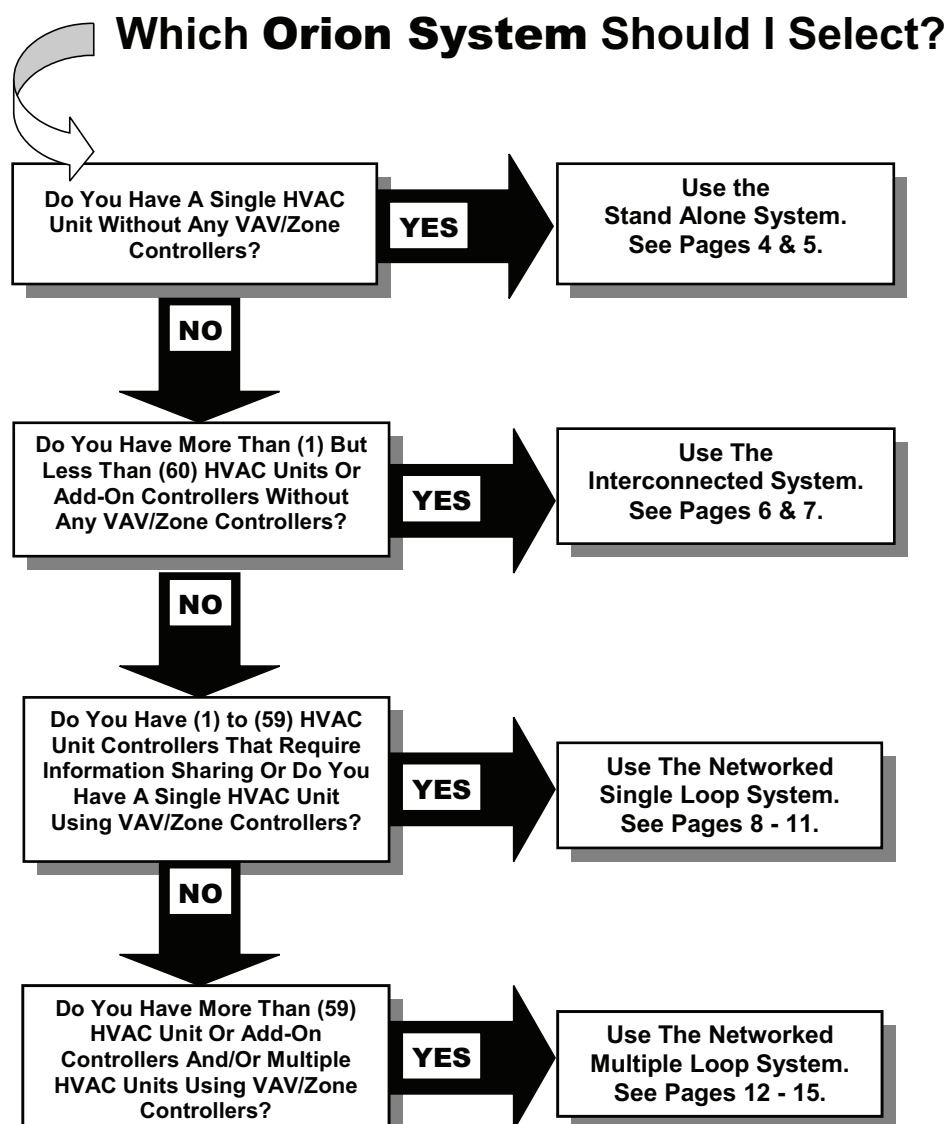

# STAND ALONE SYSTEM

## Operator Interfaces

### Overview

The Stand Alone system is used when you have a single HVAC Unit Controller. Configuring and status monitoring are accomplished by selecting and installing an operator interface. The selection of the operator interface is related to the requirements of the job. One or more of the operator interfaces can be used for system configuration and monitoring. Following is a list and block connection diagrams of the operator interface options available along with their capabilities and limitations. For detailed wiring and connection diagrams of the Stand Alone system, see page 16.

### Stand Alone System Operator Interface Options

#### Modular Service Tool SD

The Modular Service Tool SD provides complete configuration and monitoring capabilities for the controller. The Service Tool connects to the controller by means of a modular cable with DIN connectors. It is normally used to configure and service the unit and then is removed by the service person upon completion of these tasks. The Service Tool is not designed for permanent installation. Generally, the service person would only connect it when servicing or reconfiguring the controller. For this reason, if continuous monitoring of the controller is required, it is better to select a Modular System Manager or an on-site computer with Prism 2 software installed for configuration and monitoring. The Service Tool can be used in conjunction with the other operator interfaces if desired.

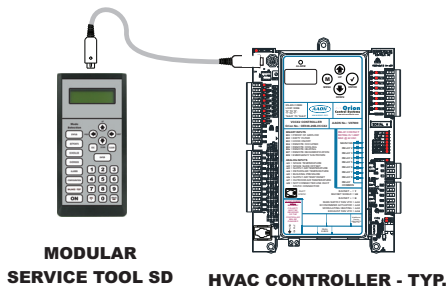

#### Stand Alone with HVAC Unit Controller Using the Modular Service Tool SD

#### Modular System Manager SD

The Modular System Manager SD provides configuration and monitoring of the controller in a package that is designed for permanent wall mounting in the space or equipment room. It is housed in an off-white plastic housing that is suitable for most decors. The Modular System Manager is also provided with alarm and override LED indicators on its faceplate. In order to use the LED indicator option with a Stand Alone system, you will also need to purchase and install a MiniLink PD 5 which can broadcast alarms to the Modular System Manager.

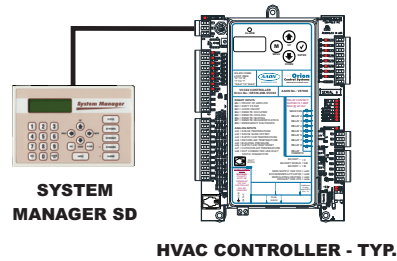

#### Stand Alone with HVAC Unit Controller Using the Modular System Manager

#### System Manager Touch Screen - Limited Access (SMTS-L)

The System Manager Touch Screen - Limited Access (SMTS-L) provides a direct graphic-enhanced, menu-driven link to view the status and adjust the space setpoints of any controller on the Orion Controls system. The SMTS-L utilizes a graphical touch screen menu system with easy to understand icons and menus. It is housed in an off-white plastic housing that is suitable for most decors and that is designed for permanent wall mounting in the space or equipment room.

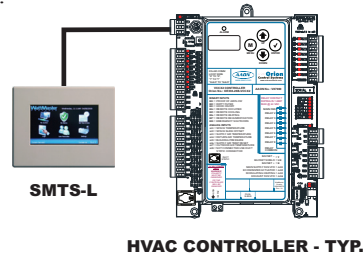

#### Stand Alone with HVAC Unit Controller Using the System Manager TS-L - (Limited Access)

#### Computer with Prism 2 Software

A computer interface can also be used in conjunction with the other operator interfaces previously described or by itself. The computer used can be a laptop or desktop PC. Orion Prism 2 software must be installed on the PC. Orion Prism 2 Software is available free of charge at our website, [www.orioncontrols.com](http://www.orioncontrols.com). In order to use an on-site or remote computer for configuration and monitoring of the controller, a CommLink 5 or USB-Link 2 must also be purchased and installed. For remote computer connection via LAN or Internet, you would purchase and install the CommLink 5 plus an IP Module. Both an on-site and remote computer can be used together if desired.

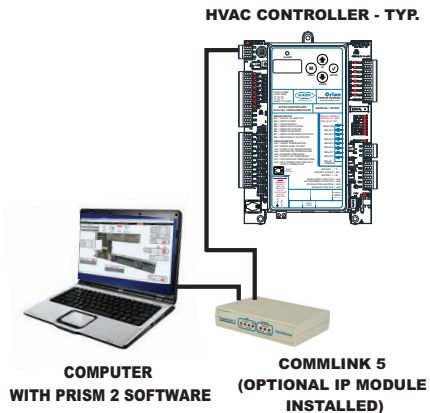
**Prism 2 Operator Interface & Communication Devices**

**Stand Alone with HVAC Unit Controller with CommLink 5 or CommLink 5 with IP Module Using a Computer and Prism 2 Software**

**Prism 2 Feature Summary**

Prism 2 provides a broad set of features:

- Easy to use
- On-site TCP/IP communications
- User-configurable description for every piece of equipment and user-defined custom screens
- Automatic retrieval of trend logs and export capability to spreadsheet and database programs
- Alarm Logs maintained in memory
- Alarm E-mail capability
- History Logs

**Computer System Requirements**

To use Prism 2 you must have a computer that meets or exceeds the following requirements:

**Operating System**

- Microsoft® Windows® 2000/ Windows® Vista, Windows® 7, 8, or 10
- NOTE:** Prism 2 is not intended for a server/client environment.

**Minimum Hardware**

- Windows® compatible computer
- Pentium 2 GHz Processor (Pentium 4 2 GHz or greater, **Recommended**)
- 1 GB RAM (or greater)
- 120 MB hard drive space
- XVGA (1024 x 768) adapter and monitor (1280 x 1024, **Recommended**)
- Network card for TCP/IP connection when IP Module is used.

**Communication Device Options**

As previously stated, some features require additional devices in order to operate. These are listed below along with a description of how they function with the Stand Alone control system.

**MiniLink Polling Device 5**

The MiniLink Polling Device 5 (MiniLink PD 5) is required when you are using the Modular System Manager SD operator interface and require the Modular System Manager SD LED lights to indicate alarm and/or override conditions. This is the only function the MiniLink PD 5 provides for the Stand Alone system.

**CommLink 5 or CommLink 5 with IP Module**

The CommLink 5 is required if you want to connect an on-site and/or remote computer to the system. If you require a remote computer to be used to interface to the system, you will also need an IP Module. The IP Module is used with the CommLink to provide for a remote computer to interface to the system via LAN or the Internet. The IP Module will allow up to 4 computer TCP/IP connections to be operating at the same time. The CommLink or CommLink with IP Module is also required for alarm notification.

**USB-Link 2**

The USB-Link 2 is a portable device that is used as an interface to connect your computer to WattMaster controllers without the need for a CommLink.

The USB-Link 2 provides a direct link to enable you to view the status and configure and adjust the setpoints of any controller on the control system communications loop using Prism 2 software.

The USB-Link 2 is small in size and is powered by the USB port of the computer it is plugged into, making it completely portable and allowing connection to the system from any controller.

**Add-On Controller Requirements**

The following controllers can be added onto your system:

- GPC-XP Controller
- Lead / Lag Controller

You must use a computer with Prism 2 software installed to configure the GPC-XP and Lead/Lag Controllers.

## Operator Interfaces

### Overview

The Interconnected system is used when you have multiple HVAC Unit Controllers. With this system, you simply daisy chain the controllers together using WattMaster communications wire or 18 gauge 2 conductor twisted pair with shield wire (Belden #82760 or equivalent). This allows for all controllers that are connected to the loop to be configured and monitored from any controller on the communications loop. Configuration and status monitoring are accomplished by selecting and installing an operator interface. The selection of the operator interface is related to the requirements of the job. Any one or more of the operator interfaces can be used for system configuration and monitoring. Following is a list and block connection diagrams of the operator interface options available along with their capabilities and limitations. For detailed wiring and connection diagrams of the Interconnected system, see page 17.

### Interconnected System Operator Interface Options

#### Modular Service Tool SD

The Modular Service Tool SD provides complete configuration and monitoring capabilities for the controllers. It can be connected to any controller on the loop. The Service Tool connects to the controller by means of a modular cable with DIN connectors. It is normally used to configure and service the unit and then is removed by the service person upon completion of these tasks. The Service Tool is not designed for permanent installation. Generally, the service person would only connect it when servicing or reconfiguration the controller. For this reason, if continuous monitoring of the controller is required, it is better to select a Modular System Manager or an on-site computer with Prism 2 software installed for configuration and monitoring. The Service Tool can be used in conjunction with the other operator interfaces if desired.

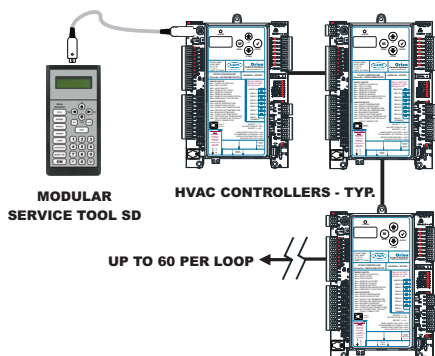

**Interconnected with HVAC Unit Controllers Using the Modular Service Tool SD**

#### Modular System Manager SD

The Modular System Manager SD provides configuration and monitoring of the controller in a package that is designed for permanent wall mounting in the space or equipment room. It is housed in an off-white plastic housing that is suitable for most decors. The Modular System Manager is also provided with alarm and override LED indicators on its faceplate. In order to use the LED indicator option with an Interconnected system, you will also need to purchase and install a MiniLink PD 5 which can broadcast alarms to the Modular System Manager.

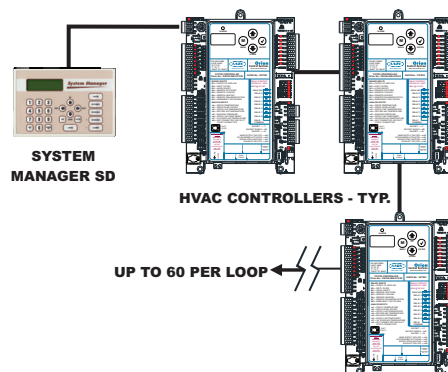

**Interconnected with HVAC Unit Controllers Using the Modular System Manager**

#### System Manager Touch Screen - Limited Access (SMTS-L)

The System Manager Touch Screen - Limited Access (SMTS-L) provides a direct graphic-enhanced, menu-driven link to view the status and to adjust the space setpoints of any controller on the Orion Controls system. The SMTS-L utilizes a graphical touch screen menu system with easy to understand icons and menus. It is housed in an off-white plastic housing that is suitable for most decors and that is designed for permanent wall mounting in the space or equipment room. In order for the ALARM Button to operate on the SMTS-L Main Screen with an Interconnected system, you will need to purchase and install a MiniLink PD in addition to the SMTS-L.

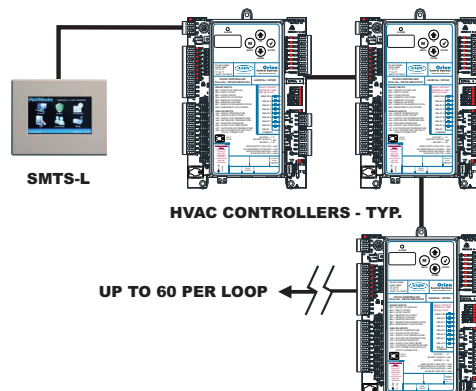

**Interconnected with HVAC Unit Controllers Using the System Manager TS-L**

## Prism 2 Operator Interface & Communication Devices

### Computer with Prism 2 Software

A computer interface can also be used in conjunction with the other operator interfaces previously described or by itself. The computer used can be a laptop or desktop PC. Orion Prism 2 software must be installed on the computer. Orion Prism Software is available free of charge from our website, [www.orioncontrols.com](http://www.orioncontrols.com). In order to use an on-site or remote computer for configuration and monitoring of the controller, a CommLink 5 or USB-Link 2 must also be purchased and installed. For remote computer connection via LAN or Internet you would purchase and install the CommLink plus an IP Module. Both an on-site and remote computer can be used together if desired.

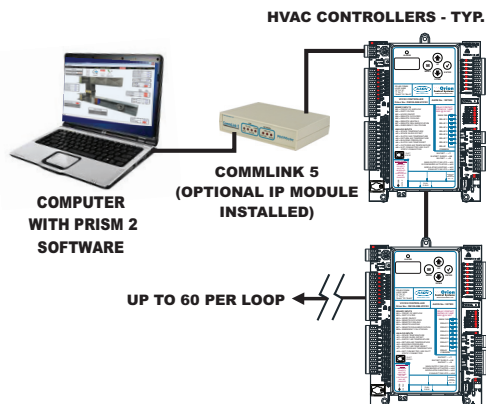

### Interconnected with HVAC Unit Controllers with CommLink 5 or CommLink 5 with IP Module Using PC and Prism 2 Software

### Prism 2 Feature Summary

Prism 2 provides a broad set of features:

- On-site TCP/IP communications
- User configurable description for every piece of equipment and user-defined custom screens
- Automatic retrieval of trend logs and export capability to spreadsheet and database programs
- Alarm Logs maintained in memory
- Alarm E-mail capability
- History Logs

### Computer System Requirements

To use Prism 2 you must have a computer that meets or exceeds the following requirements:

#### Operating System

- Microsoft® Windows® 2000/ Windows® Vista, Windows® 7, 8, or 10
- NOTE:** Prism 2 is not intended for a server/client environment.

#### Minimum Hardware

- Windows® compatible computer
- Pentium 2 GHz Processor (Pentium 4 2 GHz or greater, **Recommended**)

- 1 GB RAM or greater)
- 120 MB hard drive space
- XVGA (1024 x 768) adapter and monitor (1280 x 1024, **Recommended**)
- Network card for TCP/IP connection when IP Module is used.

### Communication Device Options

As previously stated, some features require additional devices in order to operate. These are listed below along with a description of how they function with the Interconnected system.

#### MiniLink Polling Device 5

The MiniLink Polling Device 5 (MiniLink PD 5) is required when you are using the Modular System Manager SD operator interface and require the Modular System Manager SD LED lights to indicate alarm and/or override conditions. This is the only function the MiniLink PD 5 provides for the Interconnected system.

#### CommLink 5 or CommLink 5 with IP Module

The CommLink 5 is required if you want to connect an on-site and/or remote computer to the system. If you require a remote computer to be used to interface to the system, you will also need an IP Module. The IP Module is used with the CommLink to provide for a remote PC to interface to the system via LAN or the Internet. The IP Module will allow up to 4 computer TCP/IP connections to be operating at the same time. The CommLink or CommLink with IP Module is also required for alarm notification.

#### USB-Link 2

The USB-Link 2 is a portable device that is used as an interface to connect your computer to WattMaster controllers without the need for a CommLink.

The USB-Link 2 provides a direct link to enable you to view the status and configure and adjust the setpoints of any controller on the control system communications loop using Prism 2 software.

The USB-Link 2 is small in size and is powered by the USB port of the computer it is plugged into, making it completely portable and allowing connection to the system from any controller.

### Add-On Controller Requirements

The following controllers can be added onto your system:

- GPC-XP Controller
- Lead / Lag Controller

You must use a computer with Prism 2 software installed to configure the GPC-XP and Lead/Lag Controllers.

# NETWORKED SINGLE LOOP SYSTEM

## System Overview and Modular Service Tool SD Operator Interface

### Overview

The Networked Single Loop system is used when you have between 1 to 59 HVAC Unit Controllers that require information sharing or are using a single HVAC Unit Controller that is to be connected to VAV/Zone Controllers. Configuration and status monitoring are accomplished by selecting and installing an operator interface. Any one or more of the operator interfaces can be used for system configuration and monitoring. Following is a list and block connection diagrams of the operators interface options available along with their capabilities and limitations. For detailed wiring and connection diagrams, see **pages 18, 19 & 20**.

### HVAC Unit Controllers

If you have 1 to 59 HVAC Unit Controllers that require information sharing, simply daisy chain the controllers together using WattMaster communications wire or 18 gauge 2 conductor twisted pair with shield wire (Belden #82760 or equivalent). The Networked Single Loop system requires that either a MiniLink PD 5 communication interface or a CommLink 5 communication interface, or both, are purchased and wired into the communications loop in a similar manner to the HVAC Unit controllers. This allows for all controllers that are connected to the loop to be configured and monitored from any controller on the communications loop. With this system the MiniLink PD 5 or CommLink 5 communication interfaces provide the ability for the controllers to share information with each other. Which communication interface you use is dependent on the job requirements and which operator interface(s) you are intending to use. See the “Communication Device Options” section that follows for more information on the MiniLink PD 5 and CommLink 5.

### HVAC Unit Controller with VAV/Zone Controllers

With this system, the VAV/Zone Controllers are daisy chained back to a single HVAC unit controller using WattMaster communications wire or 18 gauge 2 conductor twisted pair with shield wire (Belden #82760 or equivalent). The Networked Single Loop system requires that either a MiniLink PD 5 communication interface or a CommLink 5 communication interface, or both, are used. This allows for all controllers that are connected to the loop to be configured and monitored from any controller on the communications loop and provides the ability for the controllers to share information with each other. If the VAV/Zone Controllers are going to be used as true VAV terminals, either communication interface can be used. If your VAV/Zone Controllers are to be used for a Zoned (voting) system, then you must use the MiniLink PD 5 as your communications interface. The CommLink 5 can also be connected to the system if you require a computer as your operator interface. See the “Communication Device Options” section that follows for more information on the MiniLink PD 5 and CommLink 5. The selection of the operator interface is related to the requirements of the job. Any one or more of the operator interfaces can be used for system configuration and monitoring.

### Networked Single Loop System Operator Interface Options

#### Modular Service Tool SD

The Modular Service Tool SD provides complete configuration and monitoring capabilities for the controllers. It can be connected to any controller on the loop. The Service Tool connects to the controller by means of a modular cable with DIN connectors. It is normally used to configure and service the unit and then is removed by the service person upon completion of these tasks. The Service Tool is not designed for permanent installation. Generally, the service person would only connect it when servicing or reconfiguration the controller. For this reason, if continuous monitoring of the controllers is required, it is better to select a Modular System Manager or an on-site computer with Prism 2 software installed for configuration and monitoring. The Service Tool can be used in conjunction with the other operator interfaces if desired.

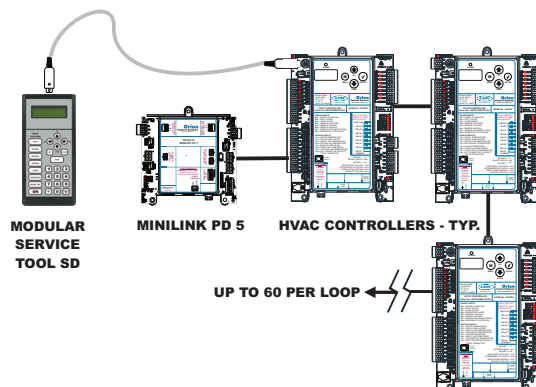

#### Networked Single Loop with HVAC Unit Controllers with MiniLink PD 5 Using Modular Service Tool SD

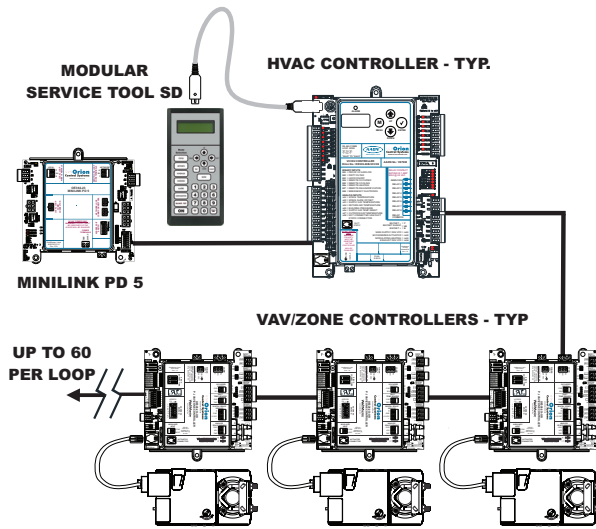

#### Networked Single Loop with VAV/Zone Controllers with MiniLink PD 5 Using Modular Service Tool SD



## Modular System Manager SD & SMTS-L Operator Interface

### Modular System Manager SD

The Modular System Manager SD provides configuration and monitoring of the controllers in a package that is designed for permanent wall mounting in the space or equipment room. It is housed in an off-white plastic housing that is suitable for most decors. The Modular System Manager is also provided with alarm and override LED indicators on its faceplate. In order to use the LED indicator option with a Networked Single Loop system, you will also need to purchase and install a MiniLink PD 5 which can broadcast alarms to the Modular System Manager.

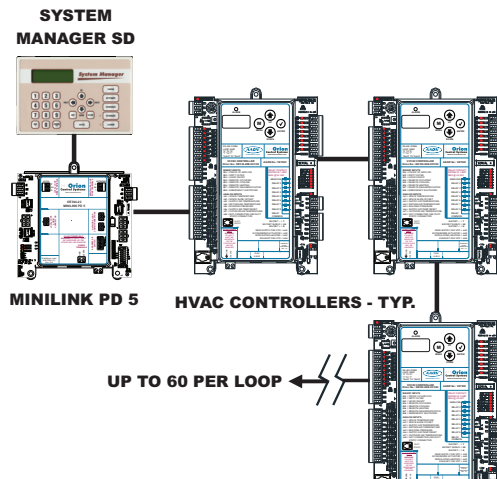

**Networked Single Loop with HVAC Unit Controllers with MiniLink PD 5 Using Modular System Manager SD**

### System Manager Touch Screen - Limited Access

The System Manager Touch Screen - Limited Access (SMTS-L) provides a direct graphic-enhanced, menu-driven link to view the status and to adjust the space setpoints of any controller on the Orion Controls system. The SMTS-L utilizes a graphical touch screen menu system with easy to understand icons and menus. It is housed in an off-white plastic housing that is suitable for most decors and that is designed for permanent wall mounting in the space or equipment room. In order for the ALARM Button to operate on the SMTS-L Main Screen with a Networked Single Loop system, you will need to purchase and install a MiniLink PD 5 in addition to the SMTS-L.

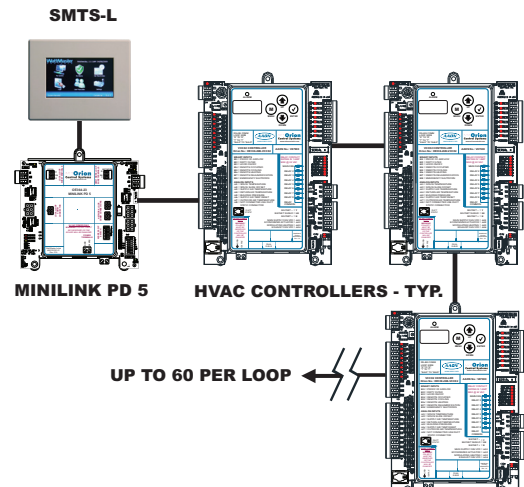

**Networked Single Loop with HVAC Unit Controllers with MiniLink PD 5 Using System Manager TS-L**

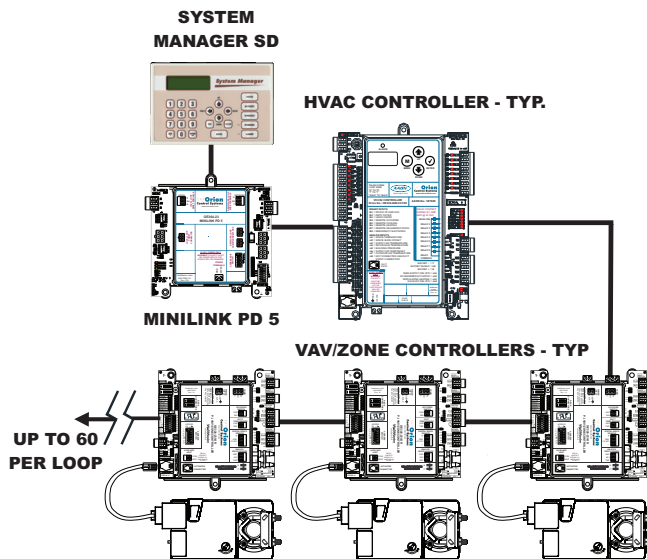

**Networked Single Loop with HVAC Unit Controller and VAV/Zone Controllers with MiniLink PD 5 Using Modular System Manager SD**

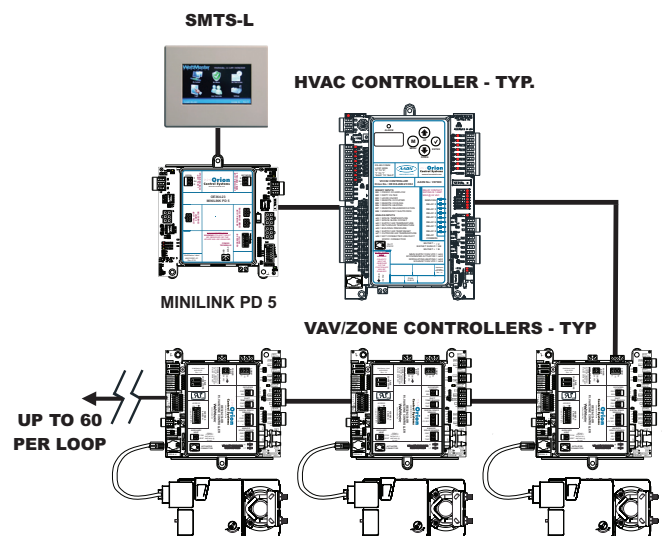

**Networked Single Loop with HVAC Unit Controller and VAV/Zone Controllers with MiniLink PD 5 Using System Manager TS-L**

# NETWORKED SINGLE LOOP SYSTEM

## Prism 2 Operator Interface

### Computer with Prism 2 Software

A computer interface can also be used in conjunction with the other operators interfaces listed previously or by itself. The computer used can be a laptop or desktop computer. Orion Prism 2 software must be installed on the PC. Orion Prism 2 software is available free of charge at our website, [www.orioncontrols.com](http://www.orioncontrols.com). In order to use an on-site or remote computer for configuration and monitoring of the controller, a CommLink 5 or USB-Link 2 must also be purchased and installed. For remote computer connection via LAN or Internet, you would purchase and install the CommLink 5 plus an IP Module. Both an on-site and remote computer can be used together if desired.

### Prism 2 Feature Summary

Prism 2 provides a broad set of features:

- Easy to use
- On-site TCP/IP communications
- User configurable description for every piece of equipment and user-defined custom screens
- Automatic retrieval of trend logs and export capability to spreadsheet and database programs
- Alarm Logs maintained in memory
- Alarm E-mail capability
- History Logs

### Computer System Requirements

To use Prism 2, you must have a computer that meets or exceeds the following requirements:

#### Operating System

- Microsoft® Windows® 2000/ Windows® Vista, Windows® 7, 8, or 10
- NOTE:** Prism 2 is not intended for a server/client environment.

#### Minimum Hardware

- Windows® compatible computer
- Pentium 2 GHz Processor (Pentium 4 2 GHz or greater, **Recommended**)
- 1 GB RAM or greater)
- 120 MB hard drive space
- X VGA (1024 x 768) adapter and monitor (1280 x 1024, **Recommended**)
- Network card for TCP/IP connection when IP Module is used.

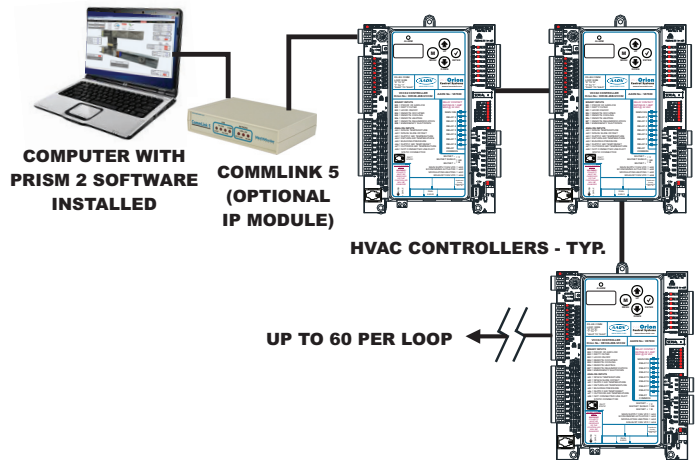

### Networked Single Loop with HVAC Unit Controllers with CommLink 5 or CommLink 5 with IP Module Using Computer and Prism 2 Software

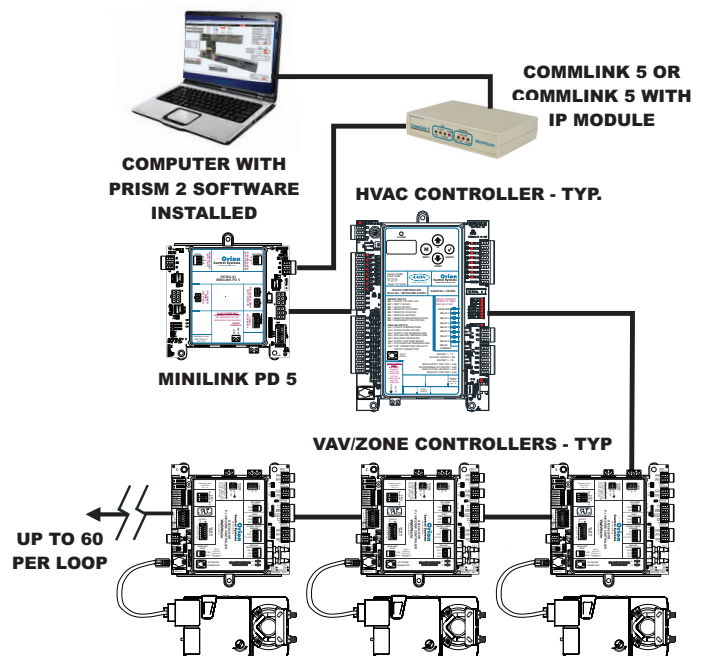

### Networked Single Loop with HVAC Unit Controllers and VAV/Zone Controllers with MiniLink PD 5 and CommLink 5 or CommLink 5 with IP Module Using Computer and Prism 2 Software

### **Communication Device Options**

As previously stated, some features require additional devices in order to operate. The Networked Single Loop system requires that you have either a CommLink 5 or MiniLink PD 5 or both installed on the system for correct operation. Other features for each device are listed in the following paragraphs along with a description of how they function with the Networked Single Loop control system.

#### **MiniLink Polling Device 5**

The MiniLink Polling Device 5 (MiniLink PD 5) is required when you are using the Modular System Manager operator interface and require the Modular System Manager LED lights to indicate alarm and/or override conditions. It is also required if you are using the System Manager Touch Screen-L and desire the ALARM button to operate on the SMTS- L Main Screen. The MiniLink PD 5 is also required if you have VAV/Zone controllers and are going to configure them into a zoned (voting) system.

#### **CommLink 5 or CommLink 5 with IP Module**

The CommLink 5 is required if you want to connect an on site and/or remote PC to the system. If you require a remote PC to be used to interface to the system, you will also need an IP Module. The IP Module is used with the CommLink 5 to provide for a remote PC to interface to the system via a local intranet or the Internet. The IP Module will allow up to 4 computer TCP/IP connections to be operating at the same time. The CommLink 5 or CommLink 5 with IP Module is also required for alarm notification.

#### **USB-Link 2**

The USB-Link 2 is a portable device that is used as an interface to connect your computer to WattMaster controllers.

The USB-Link 2 provides a direct link to enable you to view the status and configure and adjust the setpoints of any controller on the control system communications loop using Prism 2 software.

The USB-Link 2 is small in size and is powered by the USB port of the computer it is plugged into, making it completely portable and allowing connection to the system from any controller. In order to view all controllers on a Networked System, a CommLink must be installed.

### **Add-On Controller Requirements**

The following controllers can be added onto your system:

- GPC-XP Controller
- Lead / Lag Controller

You must use a computer with Prism 2 software installed to configure the GPC-XP and Lead/Lag Controllers.

## System Overview

### Overview

The Networked Multiple Loop system is used when you have more than 59 HVAC Unit Controllers and/or are using multiple HVAC Unit Controllers that are connected to VAV/Zone Controllers. These groups of controllers are broken up into multiple “Local Loops” which connect to each other via the “Network Loop”. Each individual MiniLink PD 5 handles its specific local loop’s communications requirements. The CommLink 5 communications interface handles all the communications between the individual MiniLink PDs to form the network loop. Up to 60 local loops can be connected together with this configuration. This provides the capability for over 3500 controllers to be networked together. For detailed wiring and connection diagrams, see [page 21](#).

### HVAC Unit Controllers

If you have more than 59 HVAC Unit Controllers, you must split them into multiple MiniLink local loops with no more than 59 controllers on a loop. Wiring on each local loop consists of the HVAC Unit Controllers daisy chained back to the MiniLink using WattMaster communications wire or 18 gauge 2 conductor twisted pair with shield wire (Belden #82760 or equivalent). The first MiniLink PD 5 on the network loop also connects to the CommLink 5 using 18 gauge 2 conductor twisted pair with shield wire. Each MiniLink PD 5 connects to the next using the same type 18 gauge, 2 conductor wire. With this system, the MiniLink and CommLink 5 communication interfaces provide the ability for all controllers on the system to share information with each other. The MiniLink PD 5 handles its local loop communications and the CommLink 5 handles network (local loop to local loop) communications. See the “Communication Device Options” section that follows for more information on the MiniLink PD 5 and CommLink 5. Configuration and status monitoring are accomplished by selecting and installing an operator interface. Any one or more of the operator interfaces can be used for system configuration and monitoring. See the section titled “Operator Interface Options” for a list and block connection diagrams of the operator interface options available along with their capabilities and limitations.

### HVAC Unit Controller and VAV/Zone Controllers

With this system, each HVAC Unit Controller that is using VAV/Zone Controllers is connected to its own MiniLink PD 5. Wiring on each local loop from the HVAC Unit Controller to the MiniLink PD 5 is accomplished by using WattMaster communications wire or 18 gauge 2 conductor twisted pair with shield wire (Belden #82760 or equivalent). The first MiniLink PD 5 on the network loop also connects to the CommLink 5 using 18 gauge 2 conductor twisted pair with shield wire. Each MiniLink PD 5 connects to the next using the same type 18 gauge, 2 conductor wire. All communications and power wiring between the MiniLink PD 5s and VAV/Zone Controllers is accomplished by using the same type 18 gauge, 2 conductor wire. With this system, the MiniLink PD 5 and CommLink 5 communication interfaces provide the ability for the controllers to share information with each other. The MiniLink PD 5 handles local loop communications and the CommLink 5 handles network (local loop to local loop) communications. See the “Communication Device Options” section that follows for more information on the MiniLink PD 5 and CommLink 5. Configuration and status monitoring are accomplished by selecting and installing an operator interface. Any one or more of the operator interfaces can be used for system configuration and monitoring. See the section titled “Operator Interface Options” that follows for a list and block connection diagrams of the operator interface options available along with their capabilities and limitations.

### Networked Multiple Loop System Operator Interface Options

#### Modular Service Tool SD

The Modular Service Tool SD provides complete configuration and monitoring capabilities for the controllers. It can be connected to any controller on the loop. The Service Tool connects to the controller by means of a modular cable with DIN connectors. It is normally used to configure and service the unit and then is removed by the service person upon completion of these tasks. The Service Tool is not designed for permanent installation. Generally, the service person would only connect it when servicing or reconfiguration of the controller. For this reason, if continuous monitoring of the controllers is required, it is better to select a Modular System Manager SD or an on site PC with Prism 2 software installed for configuration and monitoring. The Service Tool can be used in conjunction with the other operator interfaces if desired.

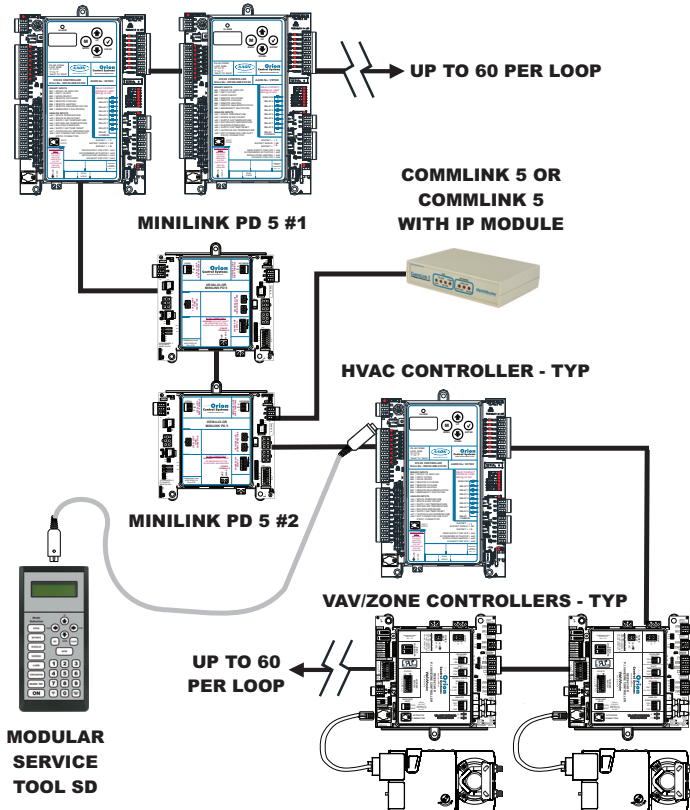

**Networked Multiple Loop with HVAC Unit Controller and VAV/Zone Controllers Using Modular Service Tool SD**

#### Modular System Manager SD

The Modular System Manager SD provides configuration and monitoring of the controllers in a package that is designed for permanent wall mounting in the space or an equipment room. It is housed in an off-white plastic housing that is suitable for most decors. The System Manager is also provided with alarm and override LED indicators on its faceplate.

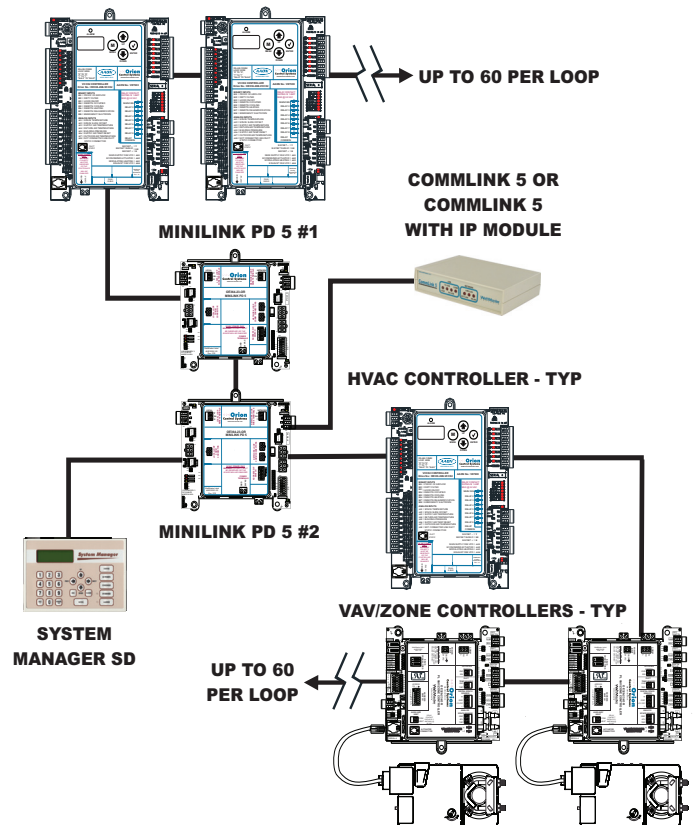

**Networked Multiple Loop with HVAC Unit Controller and Non Modular VAV/Zone Controllers Using Modular System Manager**

# NETWORKED MULTIPLE LOOP SYSTEM

## SMTS-L & Prism 2 Operator Interfaces

### System Manager Touch Screen-L (Limited Access)

The System Manager Touch Screen - Limited Access (SMTS-L) provides a direct graphic-enhanced, menu-driven link to view the status and to adjust the setpoints of any controller on the Orion Controls system. The SMTS-L utilizes a graphical touch screen menu system with easy to understand icons and menus. It is housed in an off-white plastic housing that is suitable for most decors and that is designed for permanent wall mounting in the space or equipment room. In order for the ALARM Button to operate on the SMTS-L Main Screen with a Networked Multiple Loop system, you will need to purchase and install a MiniLink PD in addition to the SMTS-L.

### Personal Computer with Prism 2 Software

A computer interface can also be used in conjunction with the other operators interfaces previously mentioned, or by itself. The PC used can be a laptop or desktop computer. Orion Prism 2 software must be installed on the PC. Orion Prism 2 Software is available free of charge at our website, [www.orioncontrols.com](http://www.orioncontrols.com). In order to use an on-site or remote PC for configuration and monitoring of the controller, a CommLink 5 or USB-Link 2 must also be purchased and installed. For remote computer connection via an intranet or Internet you would purchase and install the CommLink 5 plus an IP Module. Both an on site and remote PC can be used together if desired.

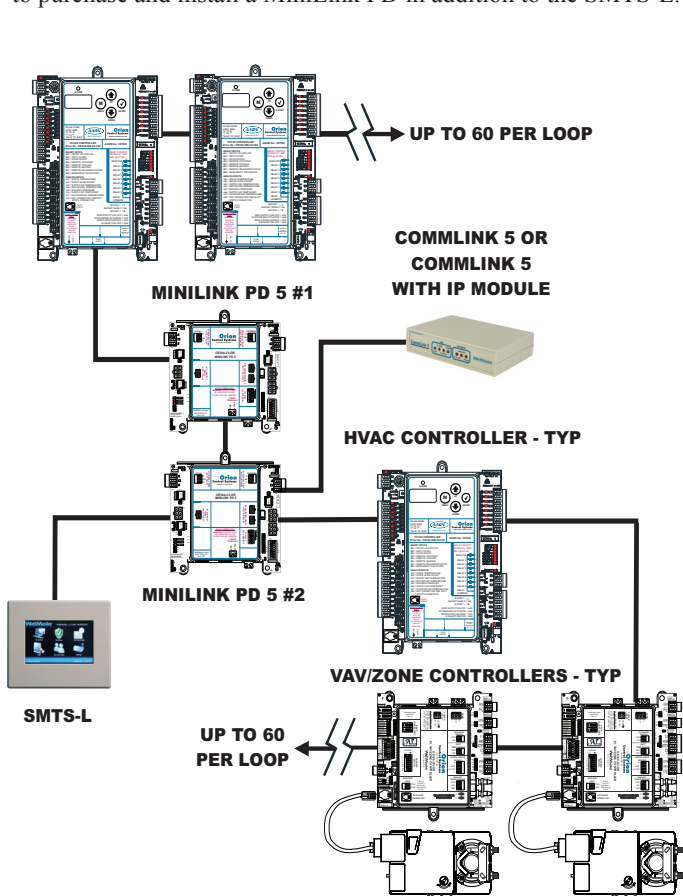

**Networked Multiple Loop with HVAC Unit Controller and VAV/Zone Controllers Using SMTS-L**

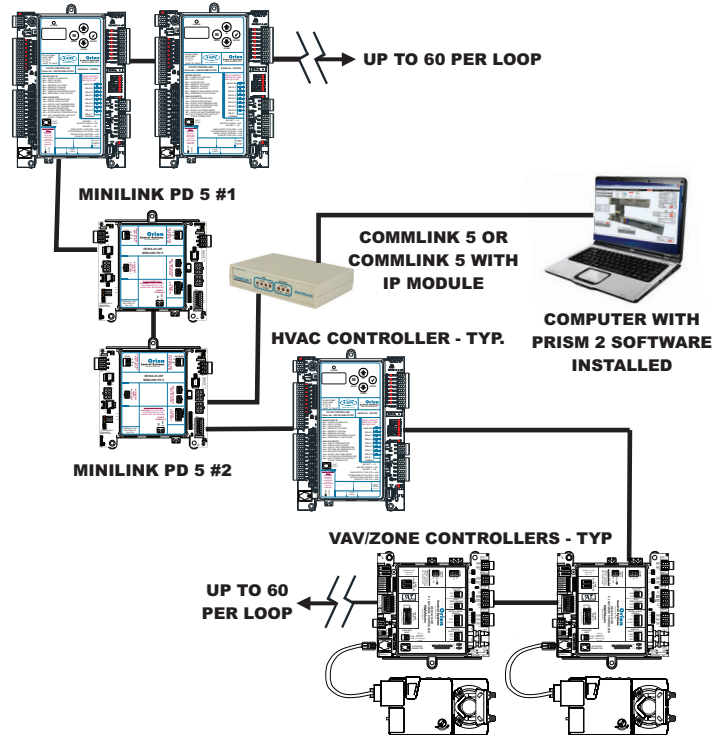

**Networked Multiple Loop with HVAC Unit Controller and Non Modular VAV/Zone Controllers Using PC and Prism 2 Software**

### Prism 2 Feature Summary

Prism 2 provides a broad set of features:

- Easy to use
- On-site TCP/IP communications
- User configurable description for every piece of equipment and user-defined custom screens
- Automatic retrieval of trend logs and export capability to spreadsheet and database programs
- Alarm Logs maintained in memory
- Alarm E-mail capability
- History Logs

### Computer System Requirements

To use Prism 2 you must have a computer that meets or exceeds the following requirements:

#### Operating System

- Microsoft® Windows® 2000/ Windows® Vista, Windows® 7, 8, or 10  
**NOTE:** Prism 2 is not intended for a server/client environment.

#### Minimum Hardware

- Windows® compatible computer
- Pentium 2 GHz Processor (Pentium 4 2 GHz or greater, **Recommended**)
- 1 GB RAM or greater)
- 120 MB hard drive space
- XVGA (1024 x 768) adapter and monitor (1280 x 1024, **Recommended**)
- Network card for TCP/IP connection when IP Module is used.

### Communication Device Options

As previously stated, some features require additional devices in order to operate. The Networked Multiple Loop system requires that you have one MiniLink PD 5 per local loop and one CommLink 5 for the entire system installed. The following paragraphs offer a description of how these devices function with the Networked Multiple Loop control system.

#### MiniLink Polling Device 5

One MiniLink Polling Device 5 (MiniLink PD 5) is required on each local loop of the Networked Multiple Loop system. It passes information between all the controllers on the local loop and communicates this information via the CommLink 5 to all controllers on the system.

#### CommLink 5 or CommLink 5 with IP Module

One CommLink 5 is required on Networked Multiple Loop Systems. The CommLink 5 can be connected to an on site PC with Prism 2 software installed to provide for configuration or monitoring of the system. If you require a remote PC to be used to interface to the system, you will also need an IP Module. The IP Module is used with the CommLink 5 to provide for a remote PC to interface to the system via a local intranet or the Internet. The IP Module will allow up to 4 computer TCP/IP connections to be operating at the same time. The CommLink or CommLink with IP Module is also required for alarm notification.

#### USB-Link 2

The USB-Link 2 is a portable device that is used as an interface to connect your computer to WattMaster controllers.

The USB-Link 2 provides a direct link to enable you to view the status and configure and adjust the setpoints of any controller on the control system communications loop using Prism 2 software.

The USB-Link 2 is small in size and is powered by the USB port of the computer it is plugged into, making it completely portable and allowing connection to the system from any controller. In order to view all controllers on a Networked System, a CommLink must be installed.

### Add-on Controller Requirements

The following controllers can be added onto your system:

- GPC-XP Controller
- Lead / Lag Controller

You must use a computer with Prism 2 software installed to configure the GPC-XP and Lead/Lag Controllers.

# STAND ALONE SYSTEM CONNECTIONS & WIRING

## Stand Alone System with Operator Interfaces

**Note:** The SMTS-L Is An End-User Interface Only. It Cannot Be Used To Configure The Controllers.



System Manager Touch Screen-L

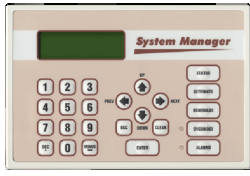

Modular System Manager SD

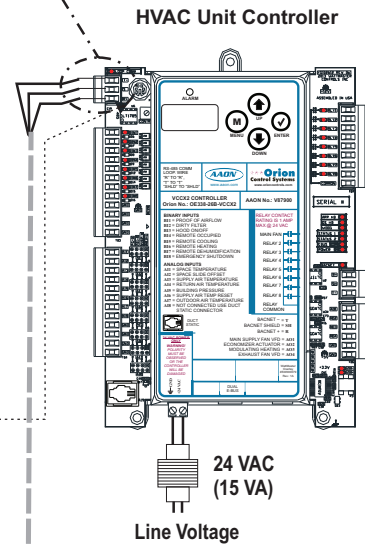
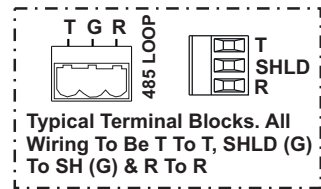
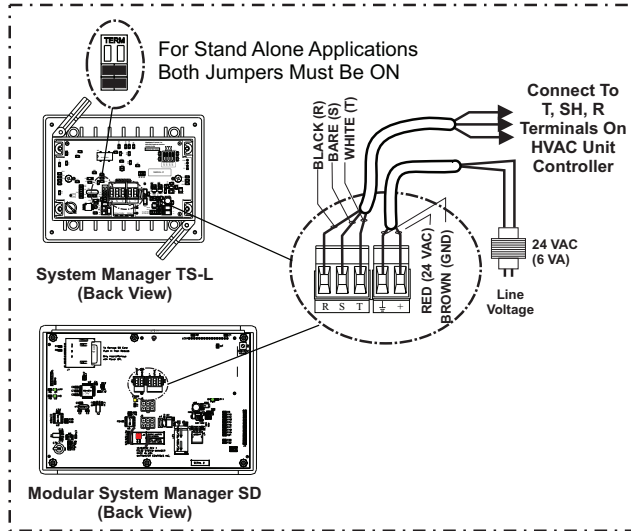

**Note:** A Modular System Manager SD, A Modular Service Tool SD Or A PC With Prism 2 Software Installed Can Be Used To Configure And Maintain The Orion Controls System.

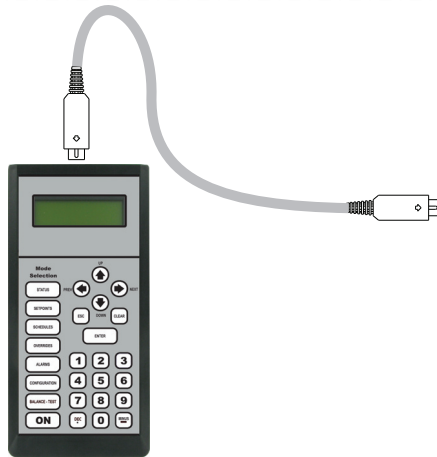

Modular Service Tool SD

**Note:**

1.) All wiring to be in accordance with local and national electrical codes and specifications.

Connect To Optional CommLink 5 Or USB-Link 2 (When Used)

For Optional CommLink 5, USB-Link 2, And Computer Connections, See Figures 7 & 8 On Pages 22-23.

Figure 1: Stand Alone System Connections & Wiring



# INTERCONNECTED SYSTEM CONNECTIONS & WIRING

## Interconnected System with Operator Interfaces

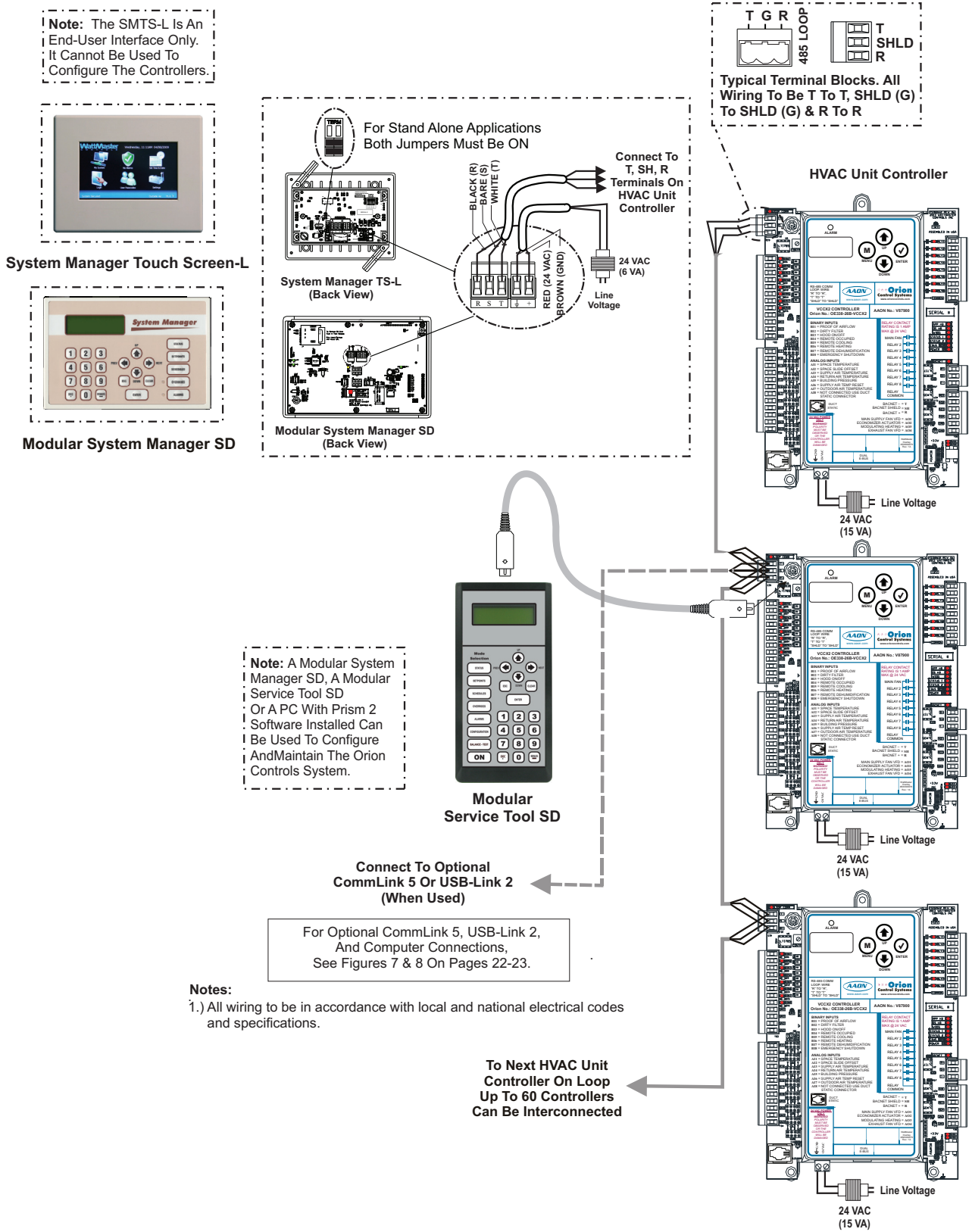

Figure 2: Interconnected System Connections & Wiring

# NETWORKED SYSTEM CONNECTIONS & WIRING

## Networked Single Loop System with CommLink 5 Only

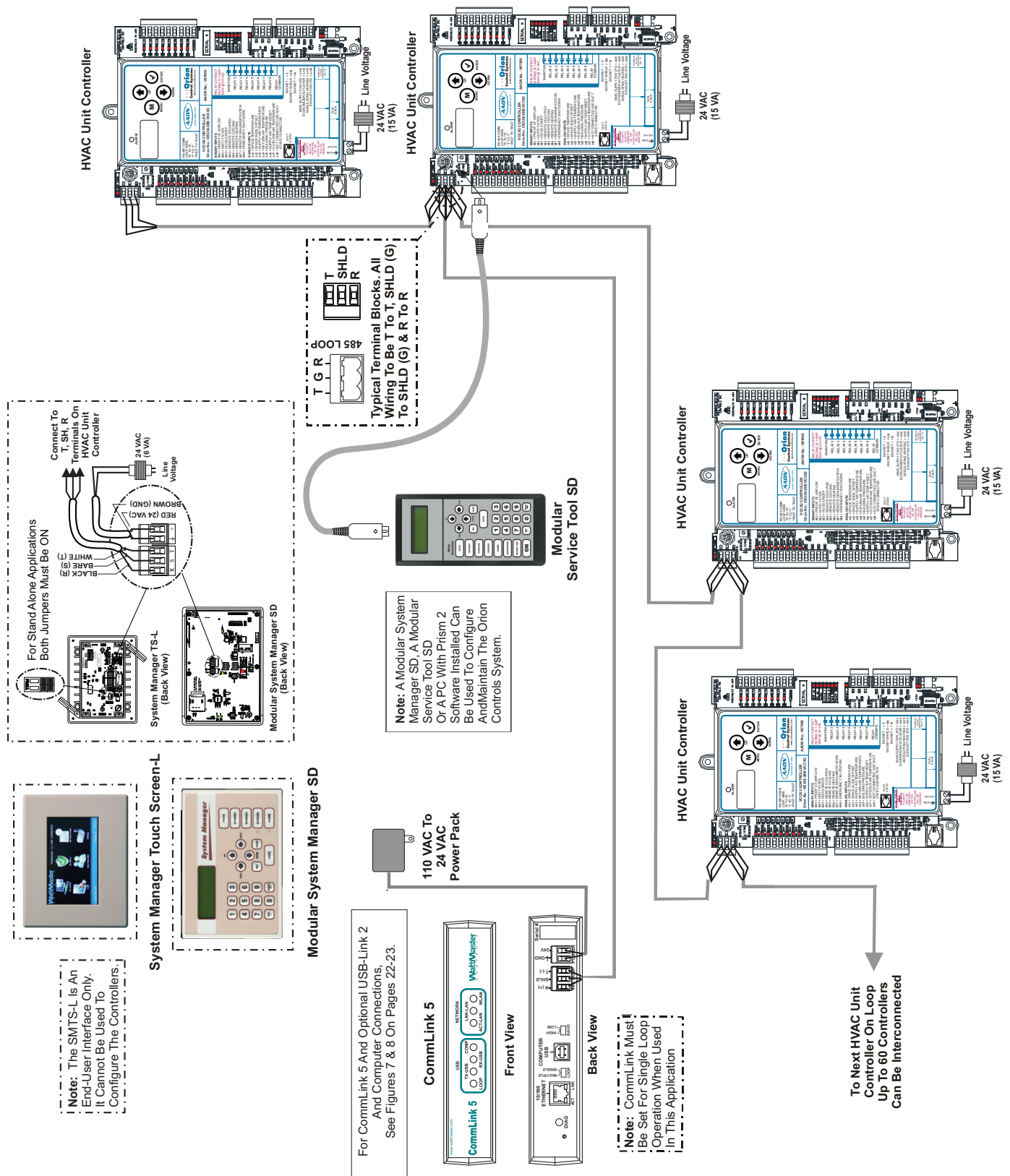

Figure 3: Networked Single Loop System With CommLink Only - Connections & Wiring

# NETWORKED SYSTEM CONNECTIONS & WIRING

## Networked Single Loop System with MiniLink PD 5 Only

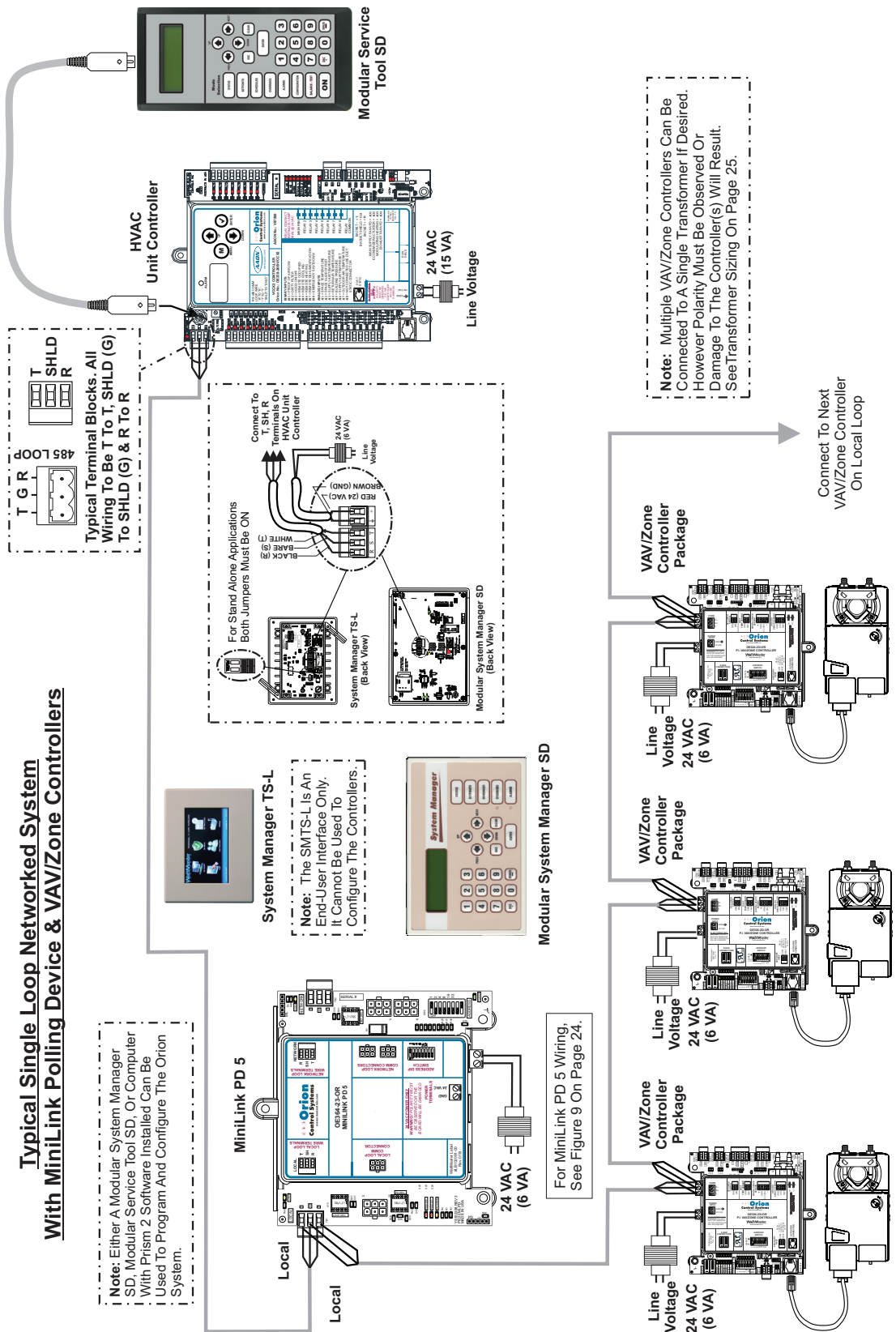

Figure 4: Networked Single Loop System With MiniLink PD Only - VAV / Zone Controllers

# NETWORKED SYSTEM CONNECTIONS & WIRING

## Networked Single Loop System With CommLink 5 & MiniLink PD 5

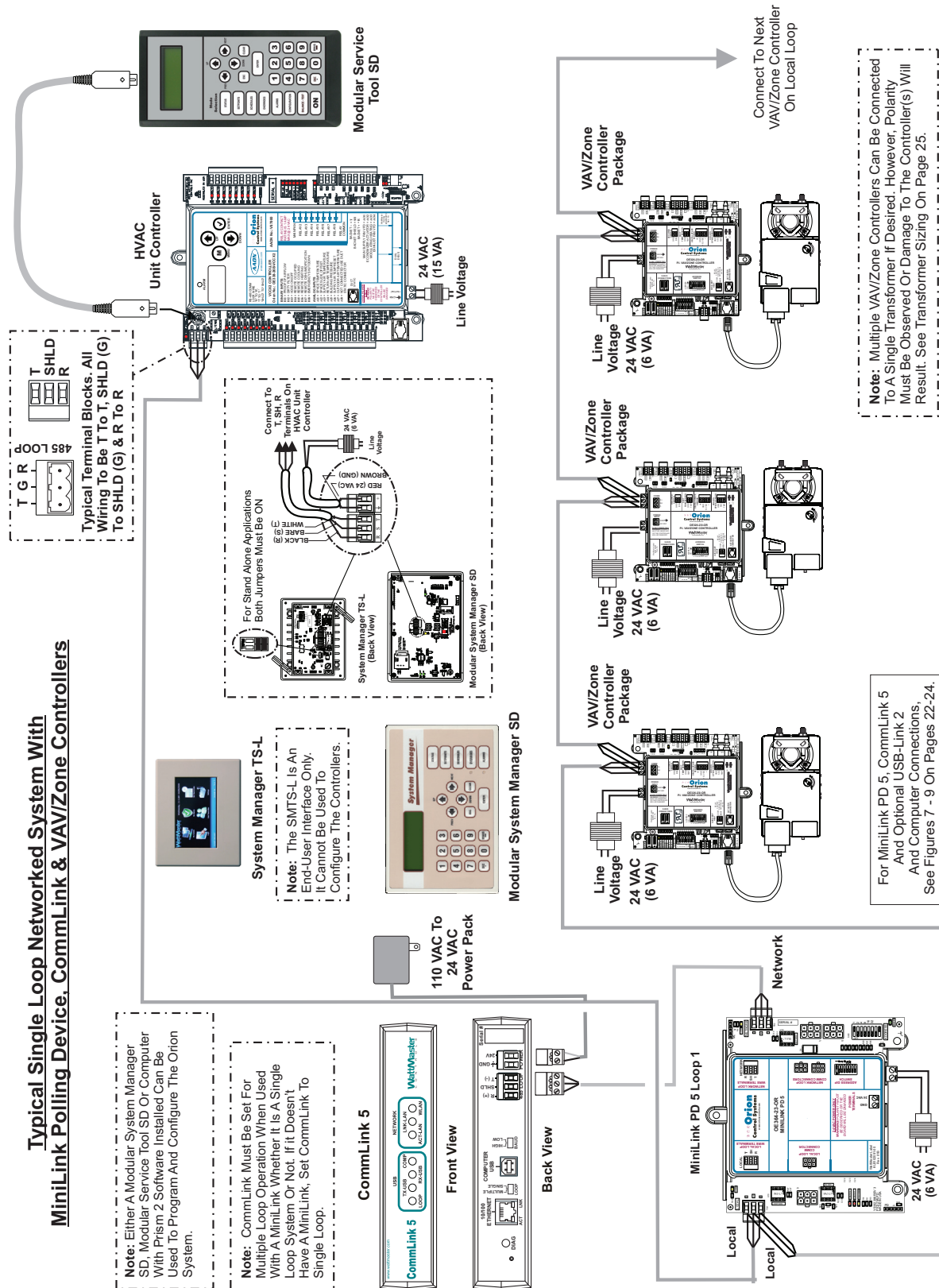

Figure 5: Networked Single Loop System With CommLink 5 & MiniLink PD 5 - VAV/Zone Controllers

# NETWORKED MULTIPLE LOOP SYSTEM CONNECTIONS & WIRING

## Networked Multiple Loop System With VAV/Zone Controllers

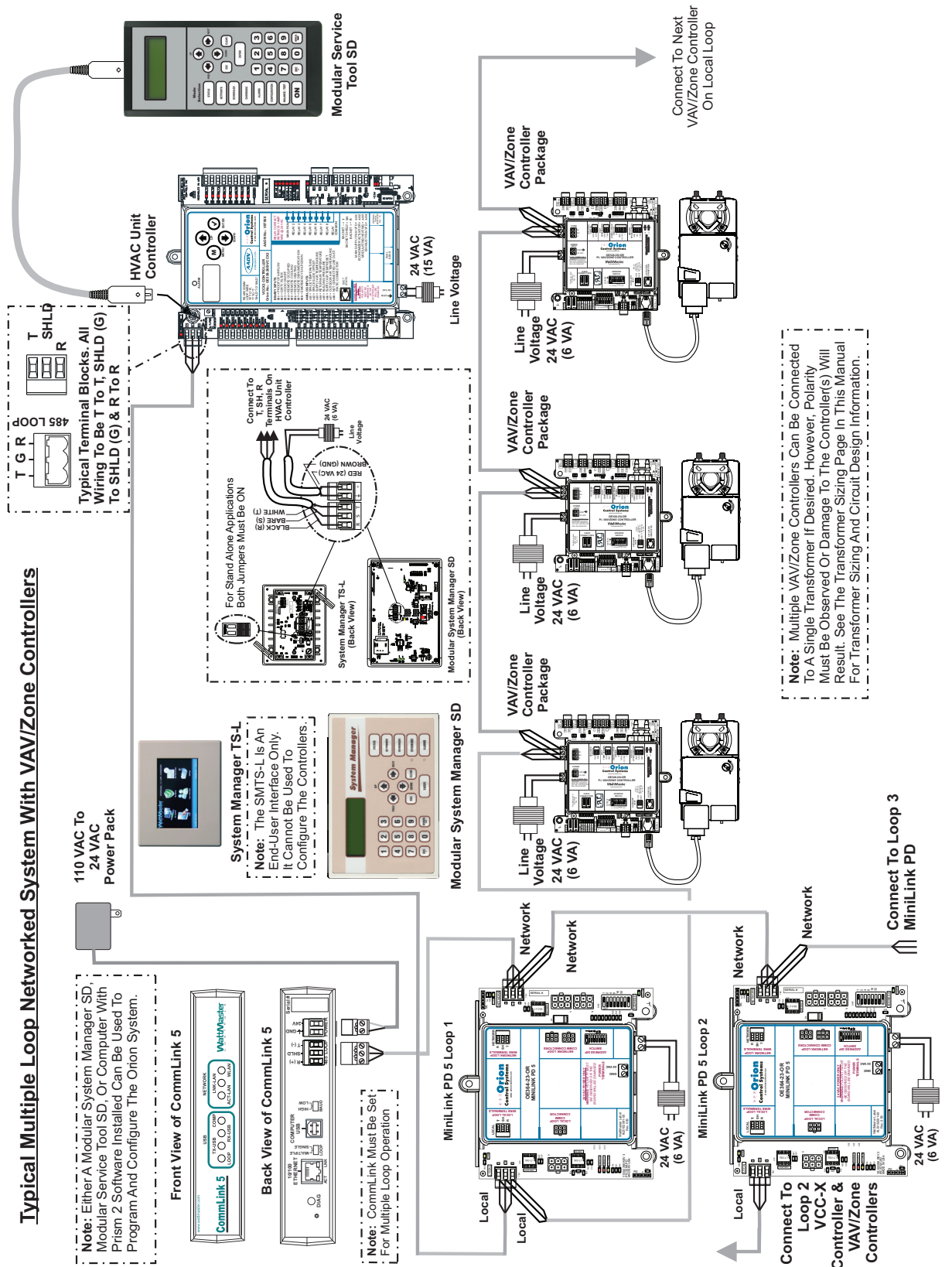

Figure 6: Networked Multiple Loop System Wiring With VAV/Zone Controllers

# COMMUNICATION CONNECTIONS & WIRING

## CommLink 5 & CommLink 5 w/IP Module

### CommLink 5 Connections & Wiring

(For more information, see the *CommLink 5 Technical Guide* & *IP Module Technical Guide*)

**WARNING!** If You Are Using The IP Module With Your CommLink, Do Not Have Your Ethernet Connection And USB Connection Connected At The Same Time. This Could Cause Unreliable Communications.

When Using A MiniLink, Switch Should Be Set To Multiple.

#### CommLink 5 Communications Interface

**NOTE:** Please Note, The R(+) And T(-) Terminals On The Communications Terminal Block Are Reversed From All Previous Versions Of The CommLink.

**WARNING!** If You Are Replacing An Earlier Version Of The CommLink With A CommLink 5, Be Aware That The Polarity Of The Terminal Block Is Reversed On The CommLink 5 From All Previous Models. You Must Always Confirm That The Polarity Is Correct When Wiring 24 VAC Power To The CommLink Power Terminal Block Or Serious Damage To The Product Will Result.

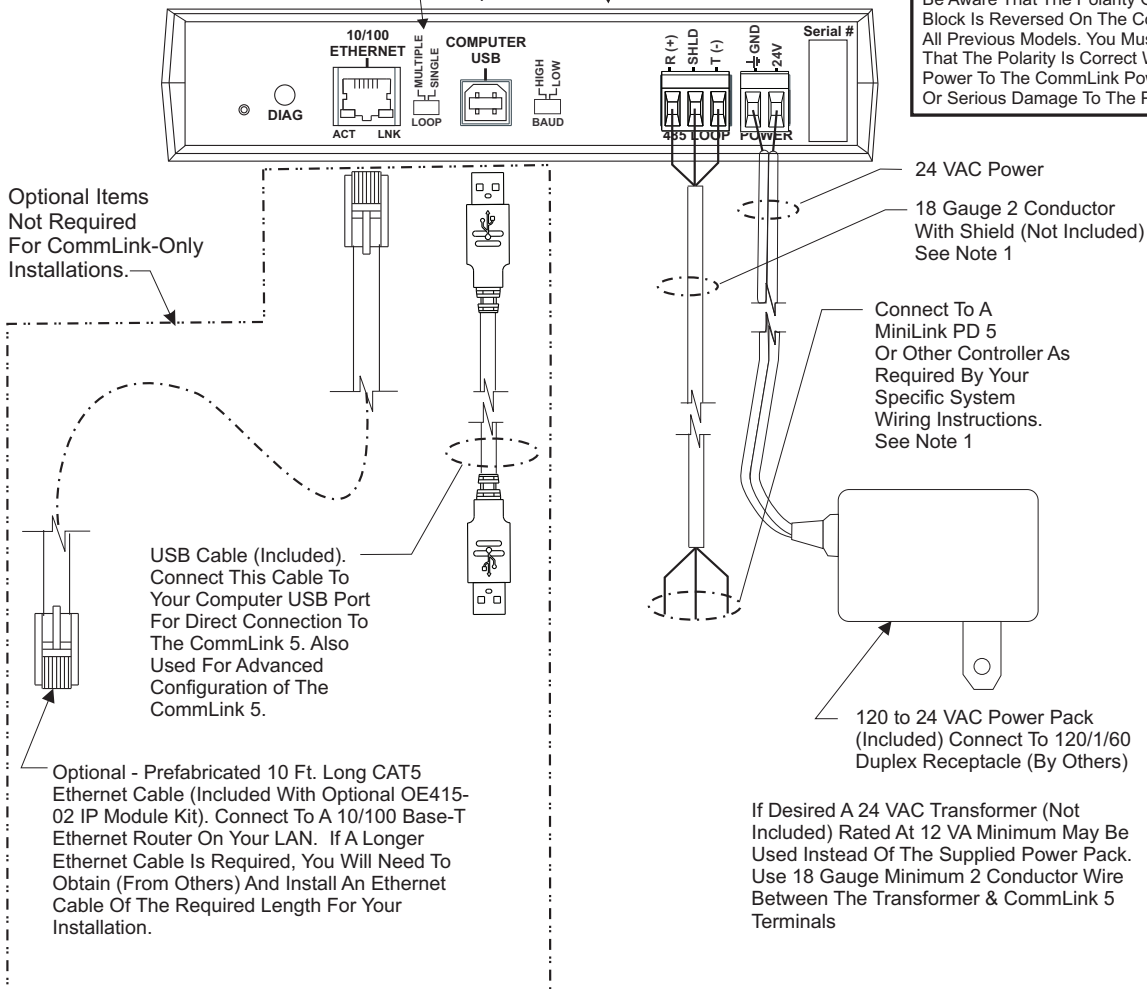

#### NOTES:

- 1) Use 18 Gauge Minimum 2 Conductor Twisted Pair With Shield Cable Belden #82760 Or Equivalent (Not Included) To Connect The CommLink 5 To A MiniLink or MiniLink PD.
- 2) For Direct Connection Via USB, Your Computer Must Have An Unused USB Port Available. Drivers For Your USB Port Are Provided On A CD Supplied With The CommLink 5. Please Follow The Directions In The CommLink 5 USB Driver Installation Section (Included) To Install And Configure The USB Drivers.
- 3) The CommLink 5 Cannot Communicate With The Control System Through Its Ethernet Port And USB Port At The Same Time.
- 4) All Wiring Must Conform To Applicable Federal, State & Local Electrical Wiring Codes.

Figure 7: Computer Connections Using CommLink 5 & CommLink 5 w/IP Module

### USB-Link 2 Connections & Wiring

(For more information, see the *USB-Link 2 Technical Guide*)

**Notes:**

1. In Order To View A Single Controller Using Prism 2, You Must Disconnect The Communication Loop From The Controller Your USB-Link Is Plugged Into, Set The USB-Link Configuration Switch To Stand Alone, Set The Type Of CommLink In Prism 2 To USB Link Stand Alone, And Cycle Power By Disconnecting And Reconnecting the USB Power Supply Cable.

Connect The USB-Link 2 Mini-DIN Cable To The Female Mini-DIN Plug Connector On Controllers That Are Supplied With Them. **NOTE:** This Allows Communications With All Controllers That Are Connected To The System When Network Communication Is Chosen.

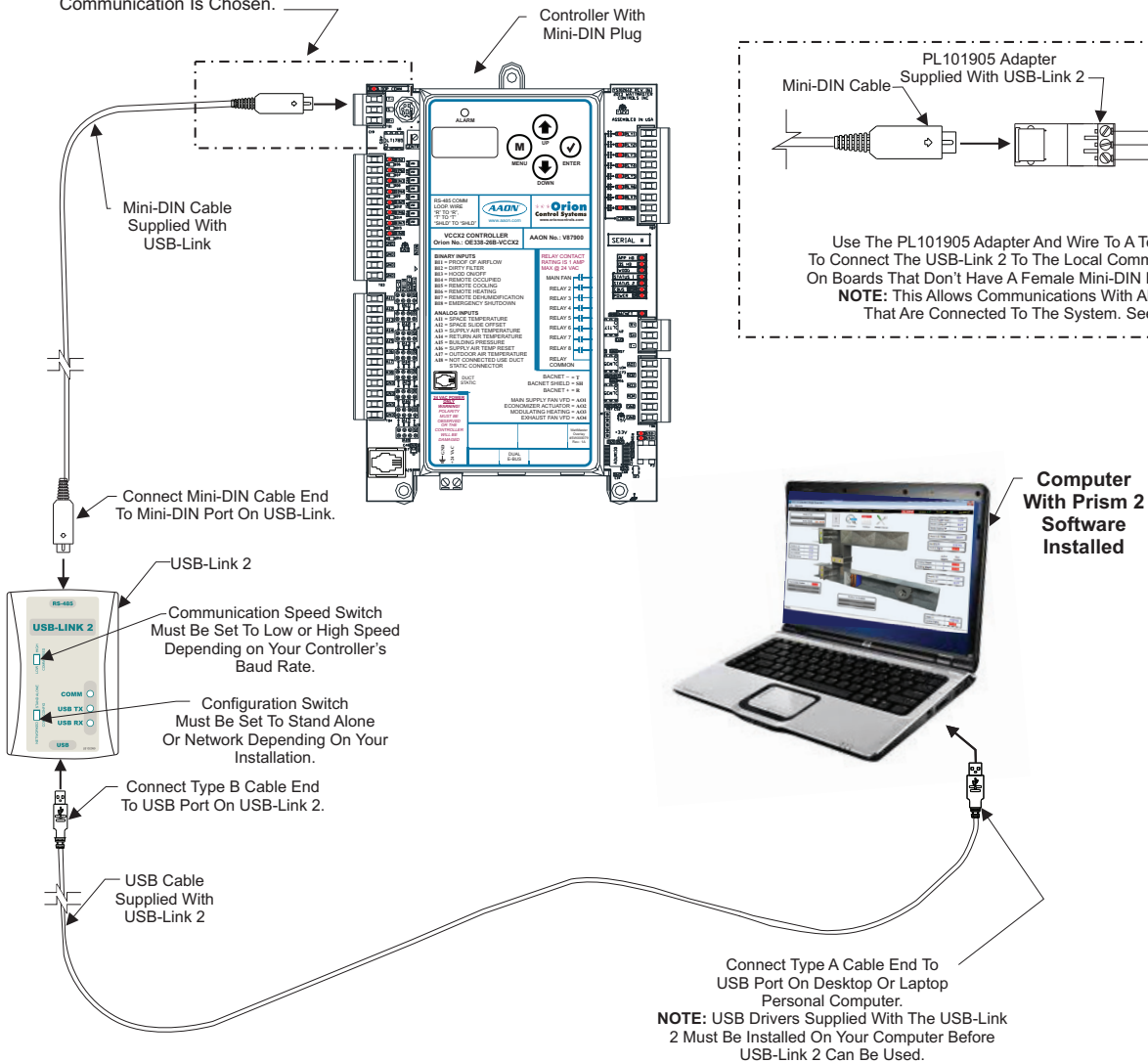
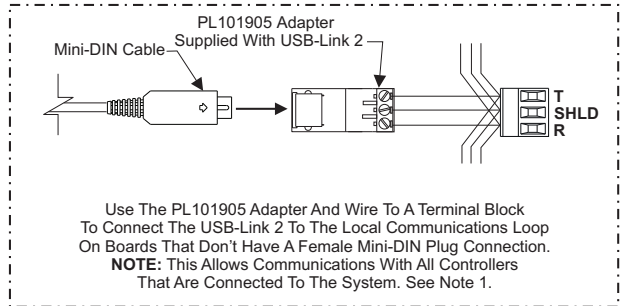
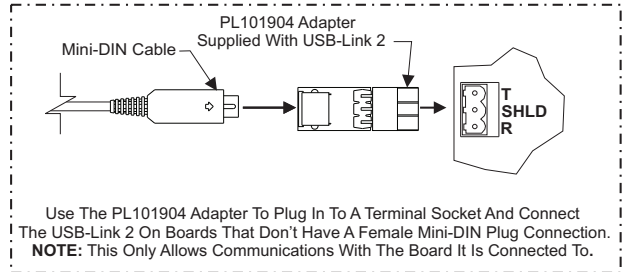

Figure 8: Computer Connections Using USB-Link 2

## MiniLink PD 5

### MLPD 5 Connections & Wiring

(For more information, see the *MiniLink PD 5 Technical Guide*)

**CAUTION:**  
Disconnect All Communication Loop Wiring From The MiniLink Before Removing Power From The Controller. Reconnect Power And Then Reconnect Communication Loop Wiring.

**NOTE:** This Network Wiring Is Not Required On Single Loop Systems Without A CommLink. When A CommLink Is Used On Single Loop Systems, Connect Network Loop Wire Terminals To The CommLink.

Connect Local Loop Terminals To T, SH & R Local Loop Terminals On First Controller On Local Loop. Be Sure To Wire T To T, SH To SH & R To R.

On Multiple Loop Systems, Connect Network Loop Wire Terminals To CommLink And Daisy Chain All MiniLink Network Terminals Together. Be Sure To Wire T To T, SH To SH & R To R.

For Address And Baud Rate Settings, See The MiniLink PD 5 Technical Guide.

Some Installers Like To Use One Large 24 VAC Transformer To Power Several Devices. This Is Allowable As Long As Polarity Is Maintained To Each Device On The Transformer Circuit.  
**WARNING: If Polarity Is Not Maintained, Severe Damage To The Devices May Result. WattMaster Recommends Using A Separate Transformer For Each Device In Order To Eliminate The Potential For Damaging Devices Due To Incorrect Polarity.**  
Using Separate Transformers Also Allows Redundancy In Case Of A Transformer Failure. Instead Of Having 8 Devices Inoperative Because Of A Malfunctioning Transformer, You Have Only 1 Device Off Line.

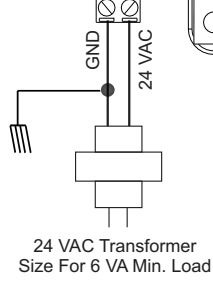

**NOTE:** All Communication Wiring Must Be Plenum-rated, Minimum 18-gauge, 2-conductor, Twisted Pair With Shield Wire. WattMaster Can Supply Communication Wire That Meets This Specification And Is Color Coded For The Network Or Local Loop. The Local Loop Wire Part Number Is WR-LL-WG-18, Is Color Coded With Green Candy Striping And Comes On A 1000 Ft. Spool. The Network Loop Wire Part Number Is WR-NL-WR-18, Is Color Coded With Red Candy Striping And Comes On A 500 Ft. Spool. If Desired, 18 Gauge Minimum Belden #82760 Or Equivalent Communications Wire May Also Be Used For Network Or Local Loop Wiring.

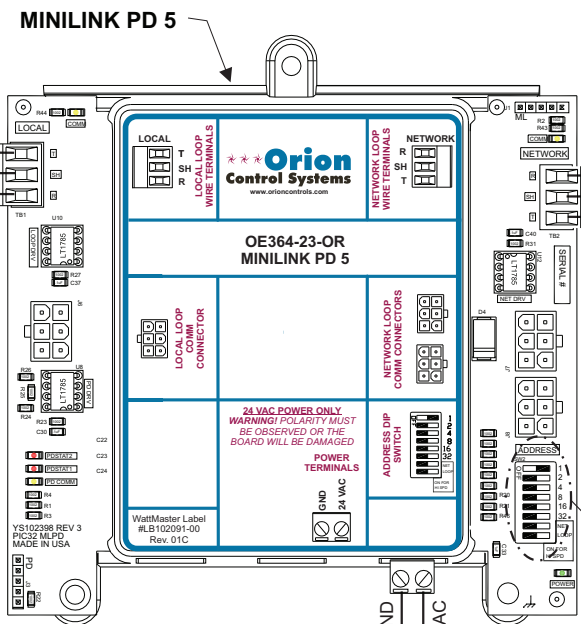

Figure 9: MiniLink PD 5 Connections & Wiring



**24 VAC Power - Transformer & Wire Sizing Considerations for Devices Without Modular Connectors**

Some installers like to use one large 24 VAC transformer to power several devices. This is allowable as long as polarity is maintained to each device on the transformer circuit. **Warning: If polarity is not maintained, severe damage to the devices may result. WattMaster Controls recommends using a separate transformer for each device in order to eliminate the potential for damaging controllers due to incorrect polarity.** Using separate transformers also allows redundancy in case of a transformer failure. Instead of having 8 controllers inoperative because of a malfunctioning transformer you have only 1 controller off line. If the installer does decide to use a large transformer to supply power to several devices, the following transformer and wire sizing information is presented to help the installer correctly supply 24 VAC power to the devices.

Following is a typical example to help the installer to correctly evaluate transformer and wiring designs.

Each GPC-XP Controller requires 8 VA @ 24VAC power. In the examples below we have a total of 8 GPC-XP Controllers.

$$8 \text{ GPC-XP Controllers @ } 8 \text{ VA each} \dots\dots\dots 8 \times 8 \text{ VA} = 64 \text{ VA.}$$

The above calculation determines that our transformer will need to be sized for a minimum of 64 VA if we are to use one transformer to power all the controllers.

Next we must determine the maximum length of run allowable for the wire gauge we wish to use in the installation. Each wire gauge below has a voltage drop per foot value we use to calculate total voltage drop.

18ga wire.....	0.00054 = voltage drop per 1' length of wire
16ga wire.....	0.00034 = voltage drop per 1' length of wire
14ga wire.....	0.00021 = voltage drop per 1' length of wire

For our example we will use 18 gauge wire. WattMaster recommends 18 gauge as a minimum wire size for all power wiring.

Next use the voltage drop per foot value for 18 gauge wire from the list above and multiply by the total VA load of the 8 controllers to be installed.

$$0.00054 \text{ (Voltage drop per foot for 18 gauge wire)} \times 64\text{VA controller load} = \mathbf{0.0346 \text{ Volts/Ft.}}$$

WattMaster controllers will operate efficiently with a voltage drop no greater than 2 Volts. Divide the total allowable voltage drop of 2 Volts by the number you arrived at above and you have the maximum number of feet you can run the 18 gauge wire with an 75 VA transformer with no more than a 2 Volt drop at the farthest controller from the transformer.

$$\frac{2 \text{ (Volts total allowable voltage drop)}}{0.0346 \text{ (Voltage drop per 1 ft. @ 64VA load)}} = 57.80 \text{ feet}$$

Parallel circuiting of the wiring instead of wiring all 8 controllers in series allows for longer wire runs to be used with the same size wire (as shown in our examples below). It is often necessary for the installer to calculate and weigh the cost and installation advantages and disadvantages of wire size, transformer size, multiple transformers, circuiting, etc., when laying out an installation. No matter what layout scheme is decided upon, it is mandatory that the farthest controller on the circuit is supplied with a minimum of 22 Volts.

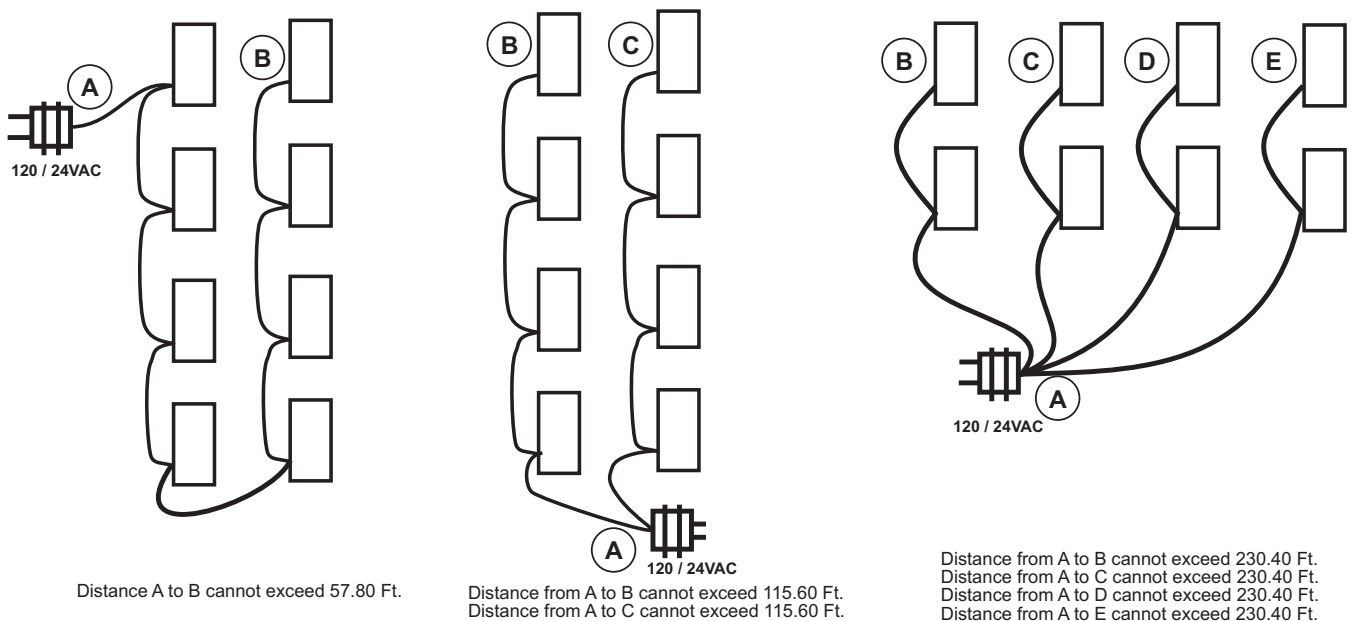

**Figure 10: VAV/Zone Controller Package With Terminal Blocks Transformer Sizing**







Form: OR-SYS-TGD-01D  
All rights reserved.

Printed in the USA

November 2017  
Copyright 2017

WattMaster Controls, Inc. • 8500 NW River Park Drive • Parkville, MO • 64152  
Phone: 866-918-1100      [www.orioncontrols.com](http://www.orioncontrols.com)      Fax: (816) 505-1101

---